



PEGGY BODICE

Sizes 2-20
with cup sizes A-H

5/8 inch (in) (1.5 cm) seam allowances are included on all pattern pieces.

SIZES 2-20 PATTERN SIZE KEY

| | |
|----|-----------|
| 2 | ————— |
| 4 | - - - - - |
| 6 | |
| 8 | - . - . - |
| 10 | |
| 12 | - . - . - |
| 14 | |
| 16 | - . - . - |
| 18 | |
| 20 | - . - . - |

SYMBOL KEY

grainline arrow



match point/
placement mark



© 2022 Charm
Patterns by Gertie.
Distribution and
Commercial Use
Prohibited.

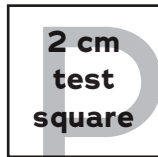
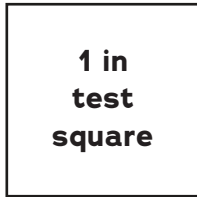

PAGE

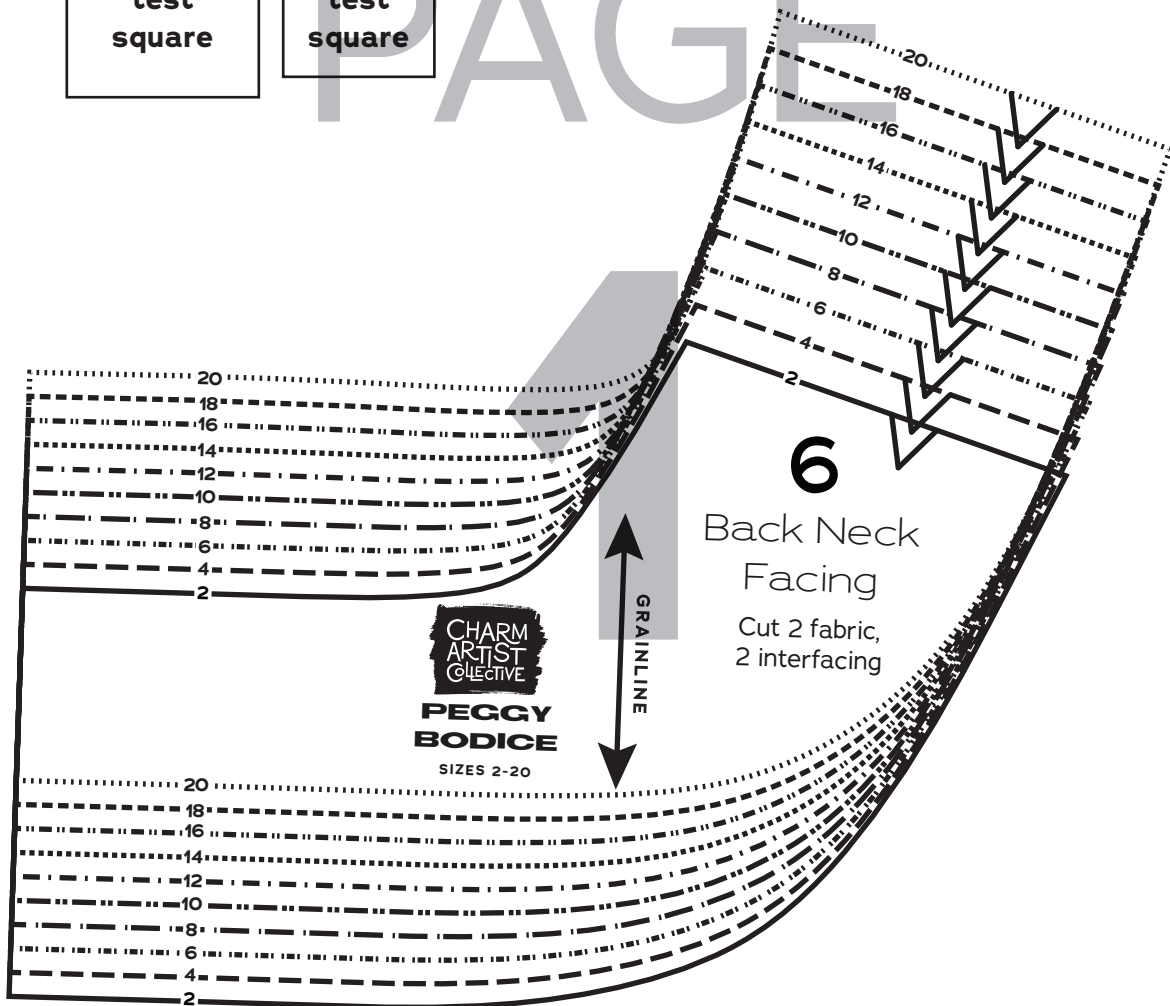

FOLD BACK THIS MARGIN



A1

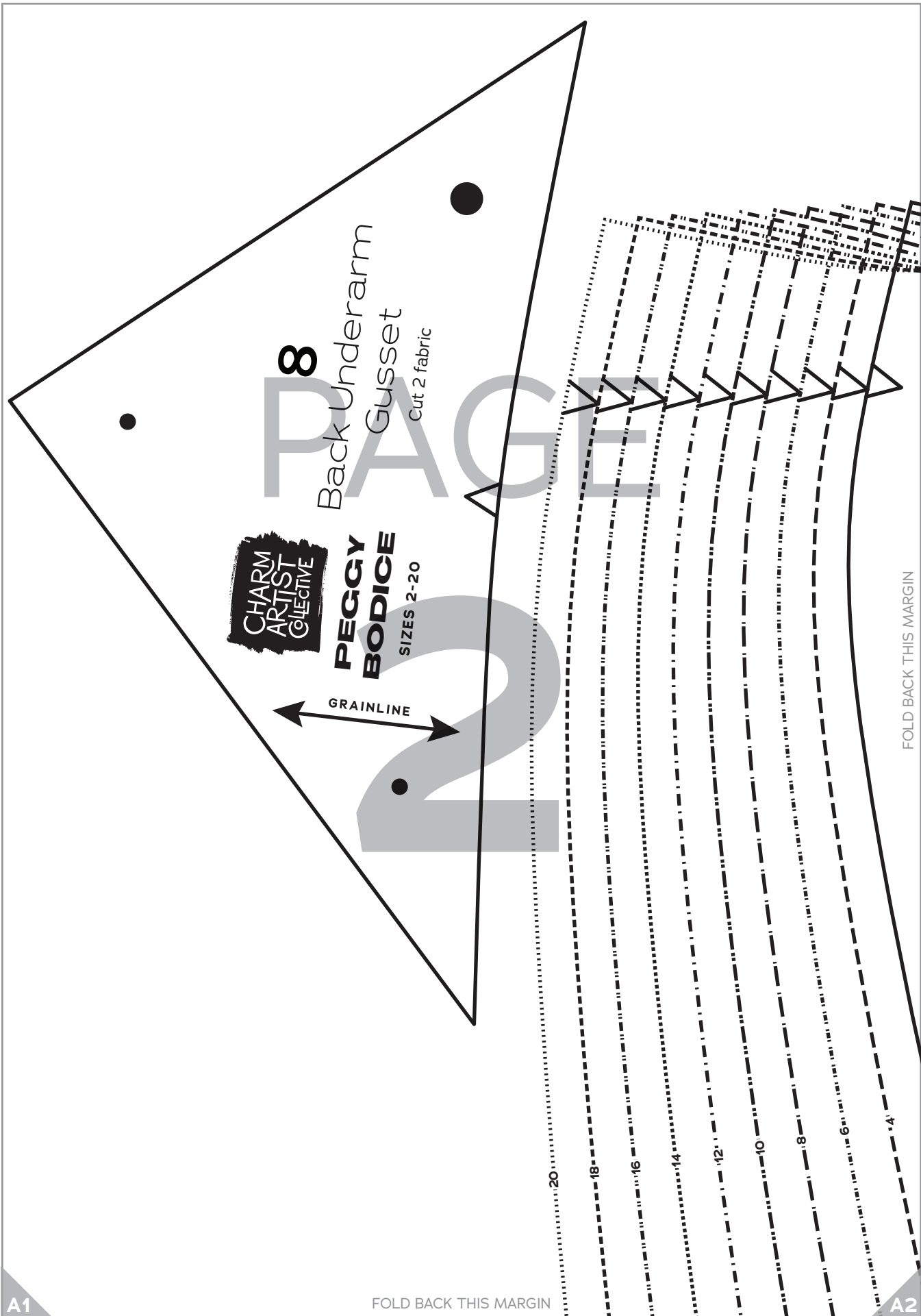

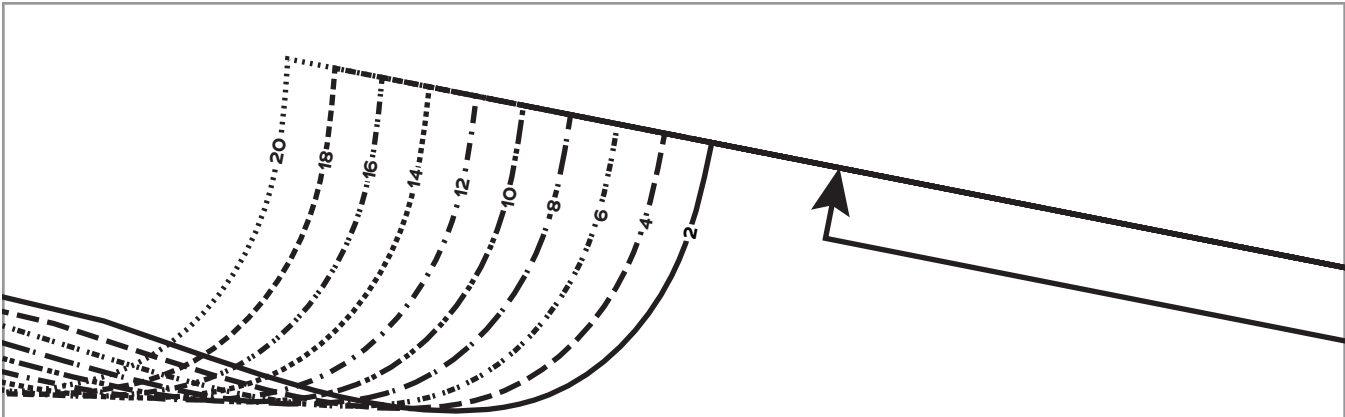

PAGE

3



**PEGGY
BODICE**
SIZES 2-20

1
Bodice Front,
A Cup
Cut 1 fabric on fold

FOLD BACK THIS MARGIN

2

A2

FOLD BACK THIS MARGIN

2
4
6
8
A3

PAGE

4

FOLD

GATHER BETWEEN NOTCHES

FOLD BACK THIS MARGIN

FOLD BACK THIS MARGIN

A3

A4

PAGE

20

18

16

14

12

10

8

6

4

2

THREE-QUARTER SLEEVE CUTTING LINE

FOLD BACK THIS MARGIN

A4

FOLD BACK THIS MARGIN

A5

PAGE

6

FOLD BACK THIS MARGIN

A5

FOLD BACK THIS MARGIN

A6

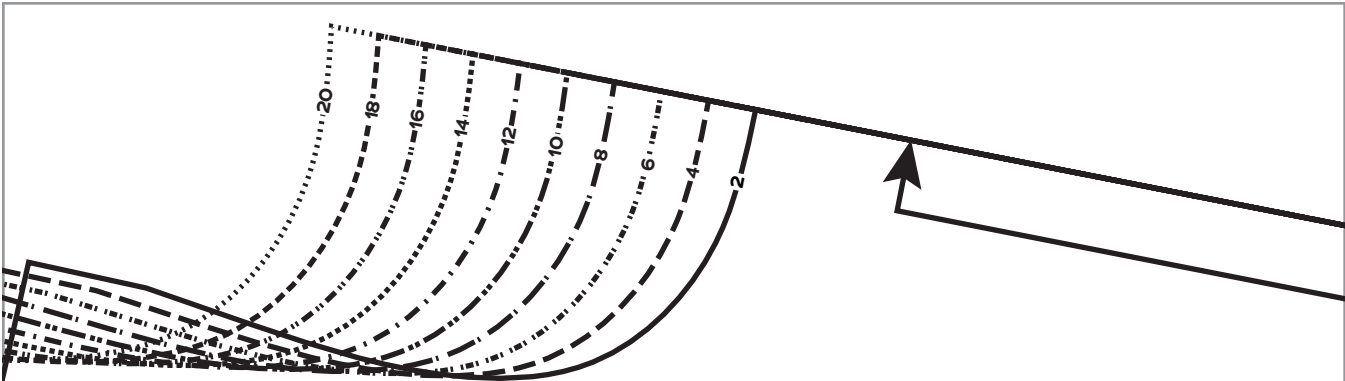

PAGE

7



PEGGY BODICE
SIZES 2-20

1
Bodice Front,
D/DD Cup
Cut 1 fabric on fold

FOLD BACK THIS MARGIN



A6

FOLD BACK THIS MARGIN

A7

PAGE

8

FOLD

GATHER BETWEEN NOTCHES

FOLD BACK THIS MARGIN

A7

FOLD BACK THIS MARGIN

A8

PAGE

9

THREE-QUARTER SLEEVE CUTTING LINE

20
18
16
14
12
10
8
6
4
2

FOLD BACK THIS MARGIN

FOLD BACK THIS MARGIN

A8

A9

PAGE 10

FOLD BACK THIS MARGIN

20
18
16
14
12
10
8
6
4
2

A9

FOLD BACK THIS MARGIN

A10

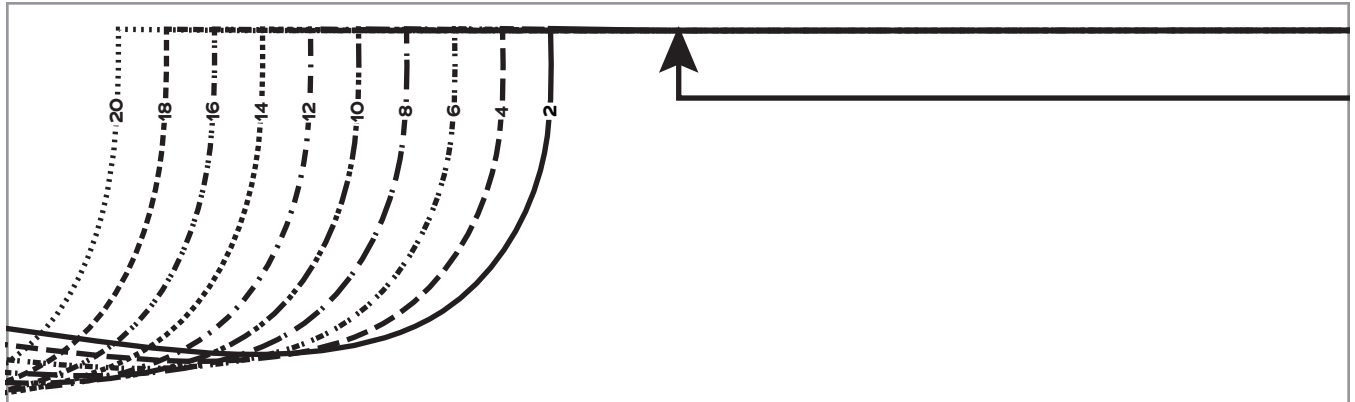

PAGE

11



**PEGGY
BODICE**

SIZES 2-20

1
Bodice Front,
H Cup
Cut 1 fabric on fold

FOLD BACK THIS MARGIN

A10

FOLD BACK THIS MARGIN

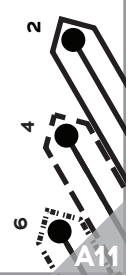

FOLD

PAGE 12

GATHER BETWEEN NOTCHES

FOLD BACK THIS MARGIN

A11

FOLD BACK THIS MARGIN

THREE-QUARTER SLEEVE CUTTING LINE

PAGE

13

20
18
16
14
12
10
8
6
4
2

FOLD BACK THIS MARGIN

A1

A2

PAGE
14

FOLD BACK THIS MARGIN

B1

FOLD BACK THIS MARGIN

B2

A2

A3

12
14
16
18
20

SHORT SLEEVE CUTTING LINE

2

4

6

8

10

12

14

16

18

20

PAGE

15

FOLD BACK THIS MARGIN

B2

FOLD BACK THIS MARGIN

B3

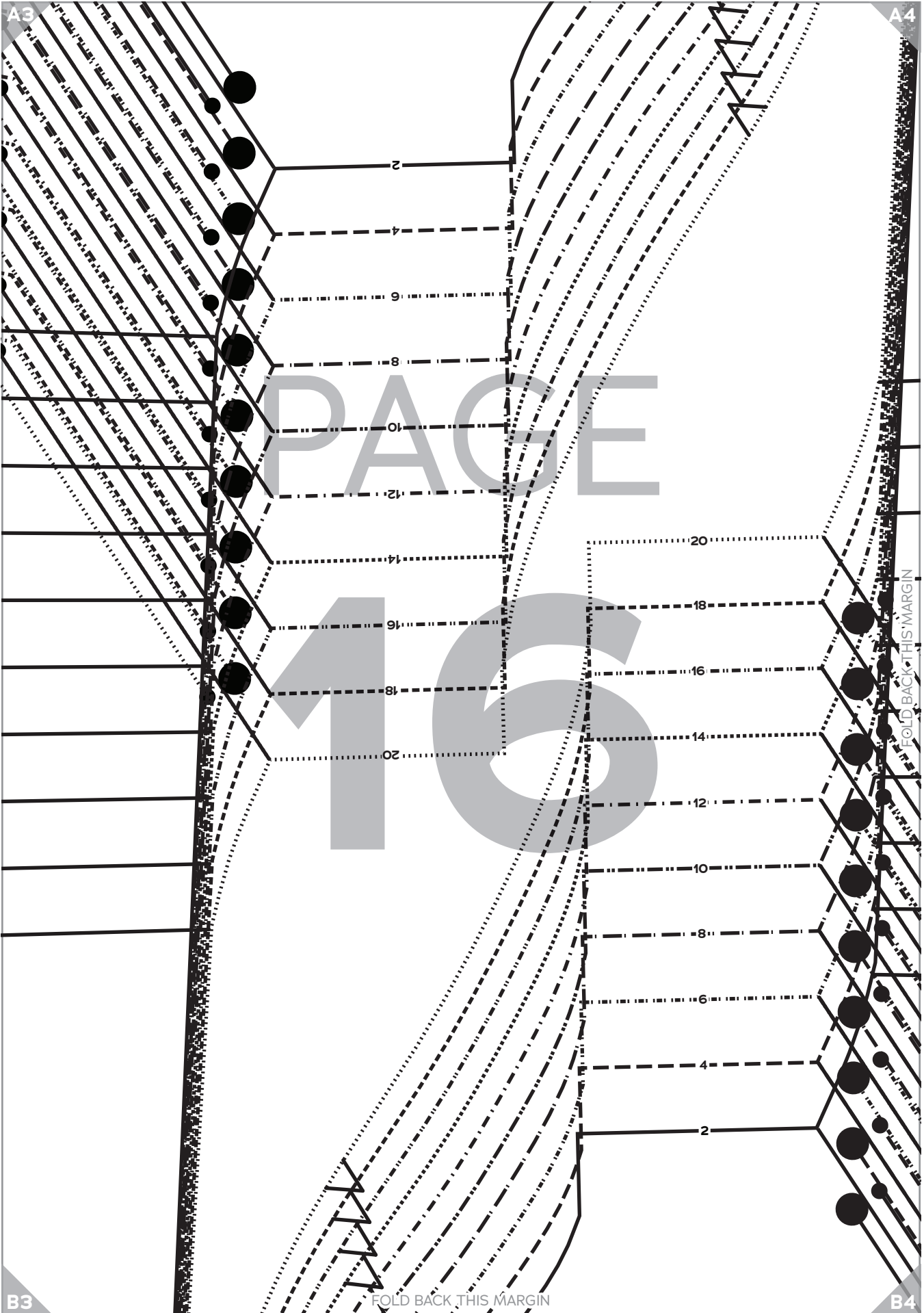

A4

A5

PAGE

17

FOLD BACK THIS MARGIN

RT SLEEVE CUTTING LINE

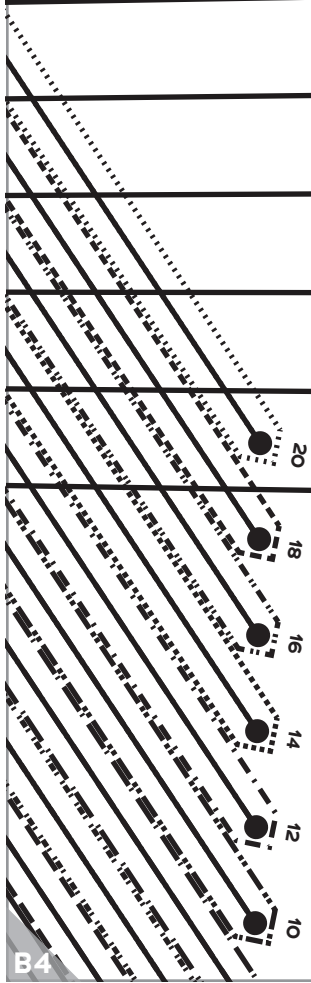

B4

FOLD BACK THIS MARGIN

B5

A5

A6

PAGE
18

DHS

FOLD BACK THIS MARGIN

B5

B6

FOLD BACK THIS MARGIN

A6

A7

SHORT SLEEVE CUTTING LINE

PAGE
19

FOLD BACK THIS MARGIN

B6

FOLD BACK THIS MARGIN

B7

A7

A8

PAGE

20

FOLD BACK THIS MARGIN

FOLD BACK THIS MARGIN

B7

B8

A8

A9

PAGE
21

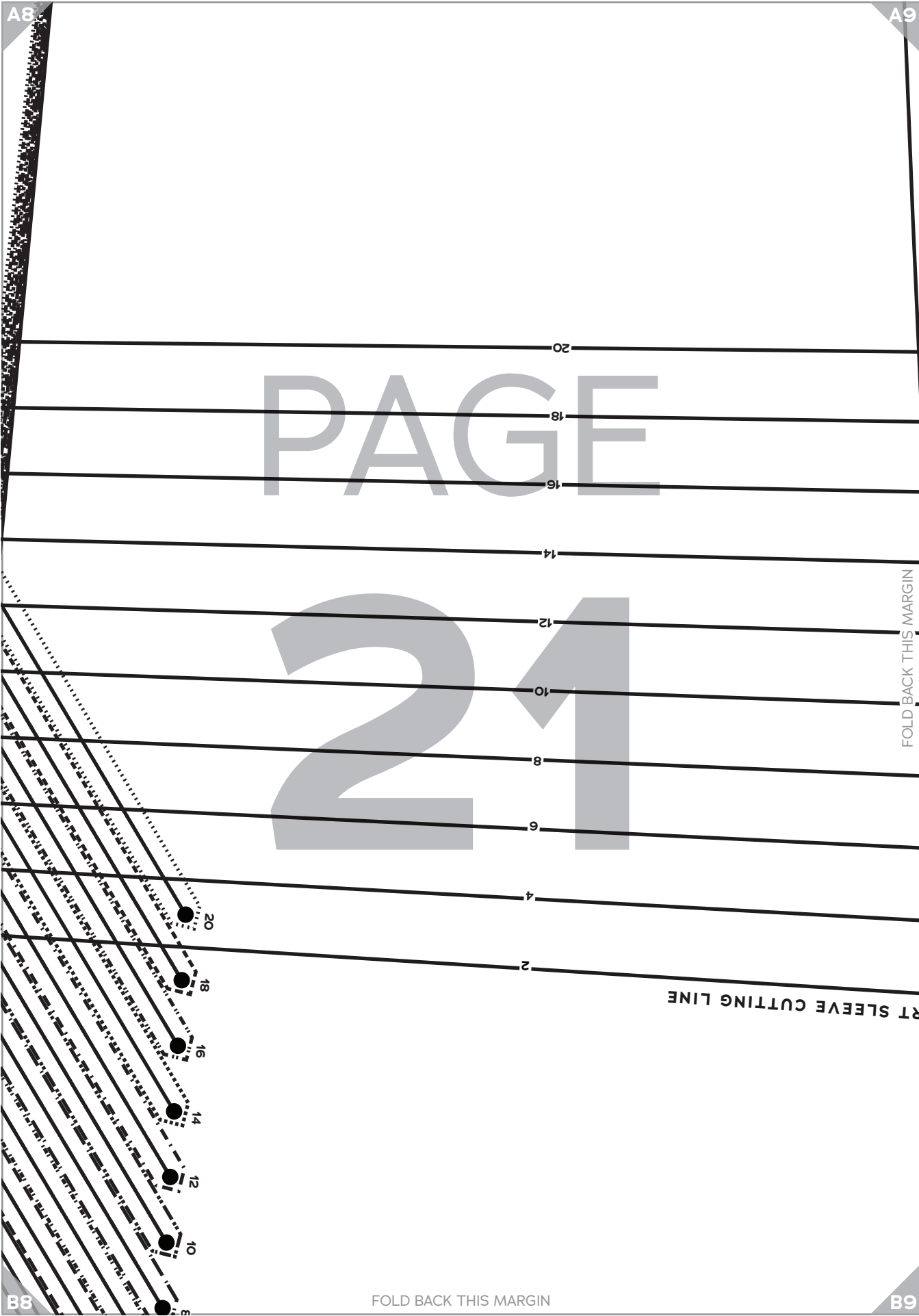

B8

FOLD BACK THIS MARGIN

B9

A9

A10

PAGE

22

FOLD BACK THIS MARGIN

OHS

B9

FOLD BACK THIS MARGIN

B10

A10

A11

SHORT SLEEVE CUTTING LINE

PAGE

23

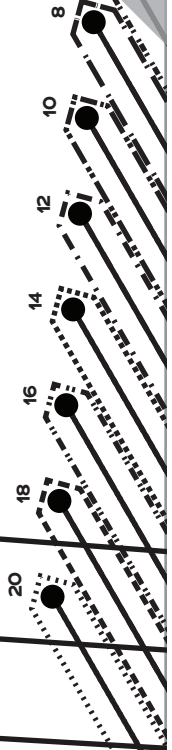

FOLD BACK THIS MARGIN

B10

FOLD BACK THIS MARGIN

B11

A11



PAGE
24

B11

FOLD BACK THIS MARGIN

FOLD BACK THIS MARGIN

PAGE

25

SHORT SLEEVE CUTTING LINE

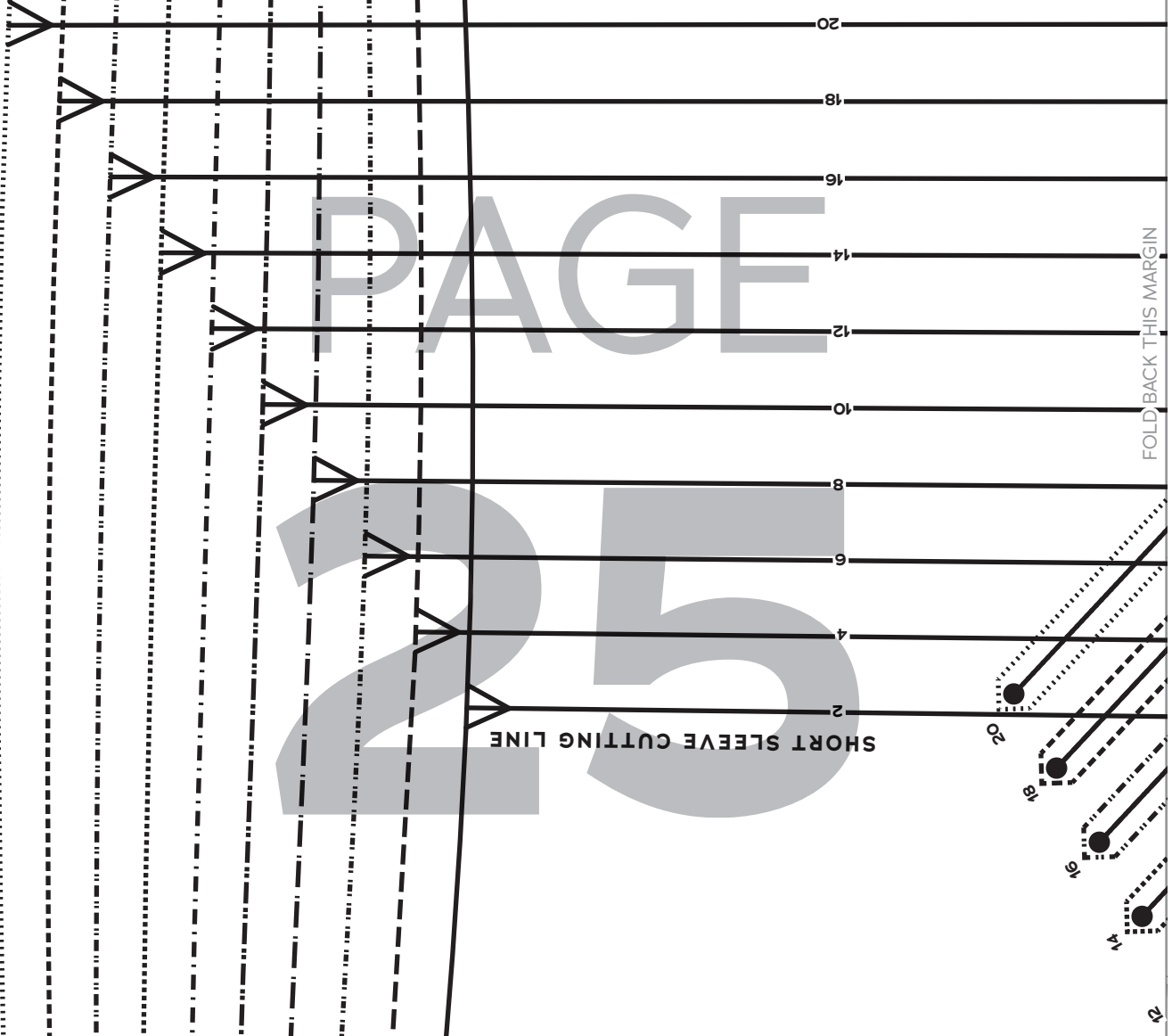

FOLD BACK THIS MARGIN

B1

B2

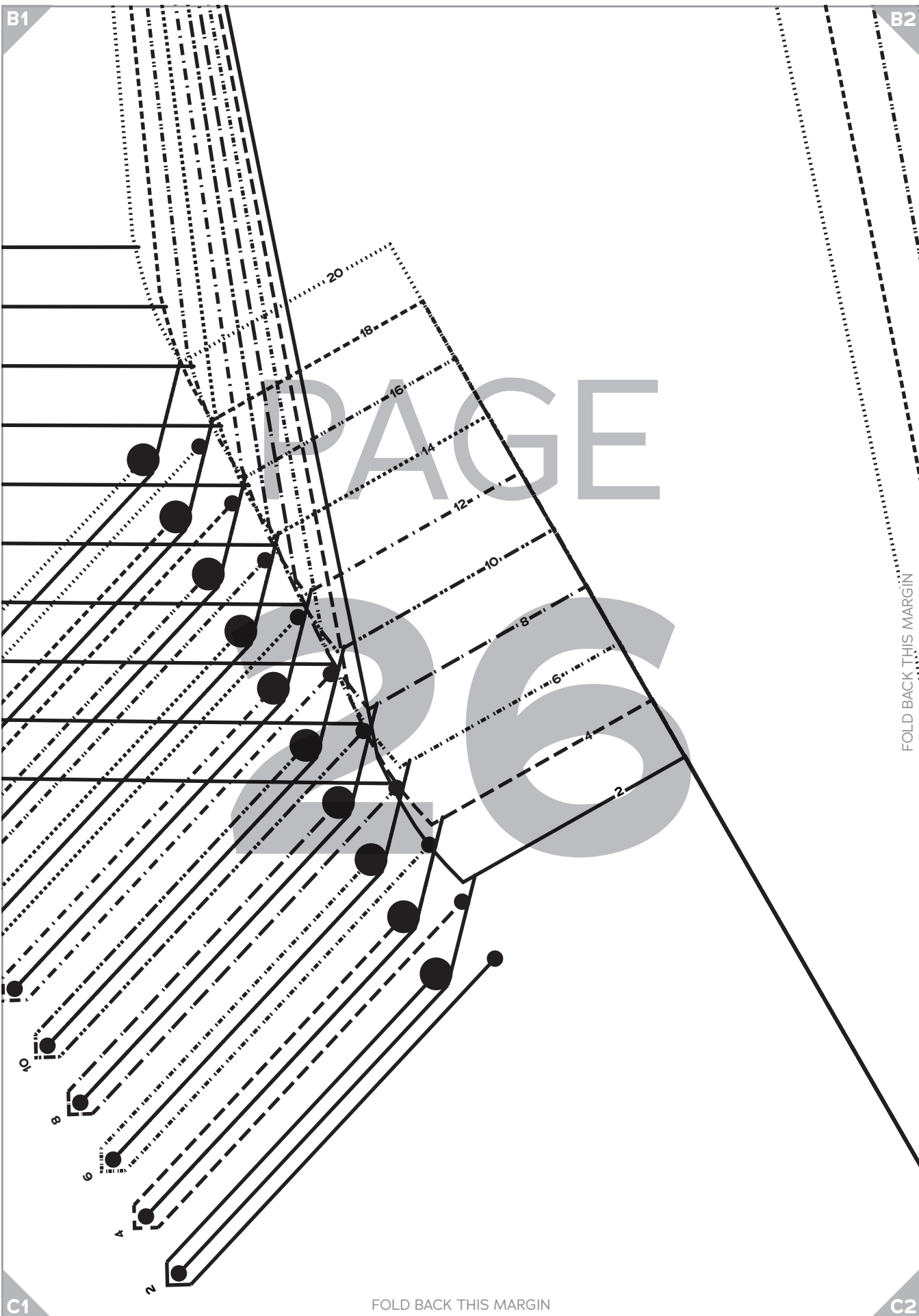

FOLD BACK THIS MARGIN

FOLD BACK THIS MARGIN

B2

B3

PAGE

THREE-QUARTER SLEEVE CUTTING LINE

2

4

6

8

10

12

14

16

18

20

FOLD BACK THIS MARGIN

27

C2

FOLD BACK THIS MARGIN

C3

B3

B4

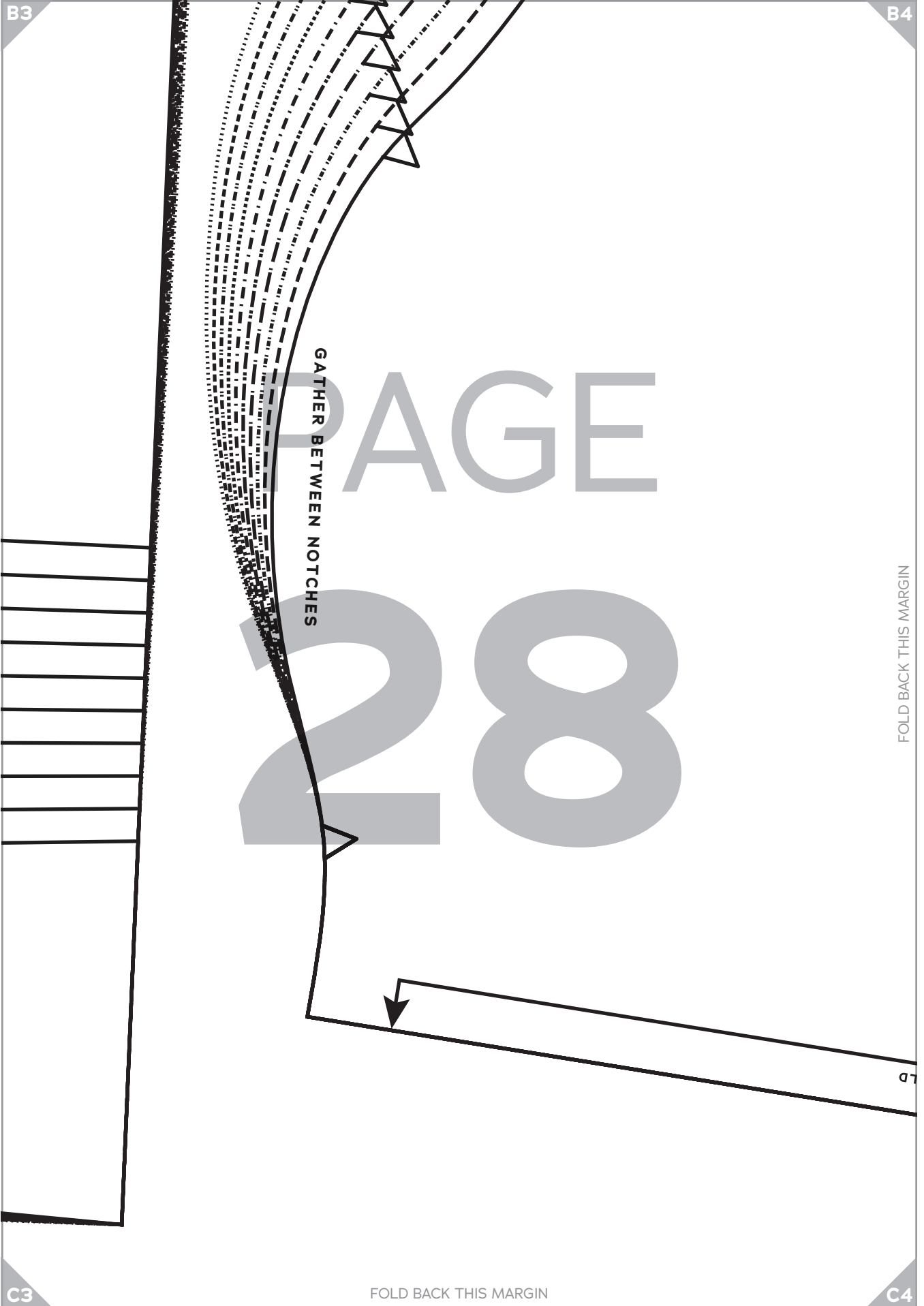

GATHER BETWEEN NOTCHES

FOLD BACK THIS MARGIN

FOLD BACK THIS MARGIN

B5

FOLD BACK THIS MARGIN



**PEGGY
BODICE**
SIZES 2-20

1
Bodice Front,
B/C Cup
Cut 1 fabric on fold

PAGE 29

B4

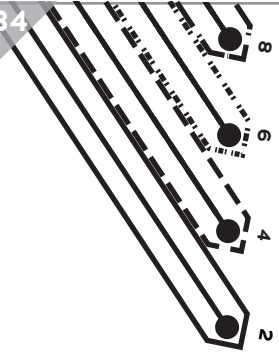

FO

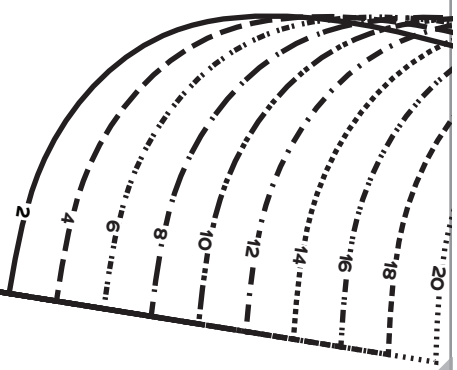

C4

FOLD BACK THIS MARGIN

C5

B5

B6

PAGE

30

FOLD BACK THIS MARGIN

FOLD BACK THIS MARGIN

C5

C6

B6

B7

PAGE

THREE-QUARTER SLEEVE CUTTING LINE

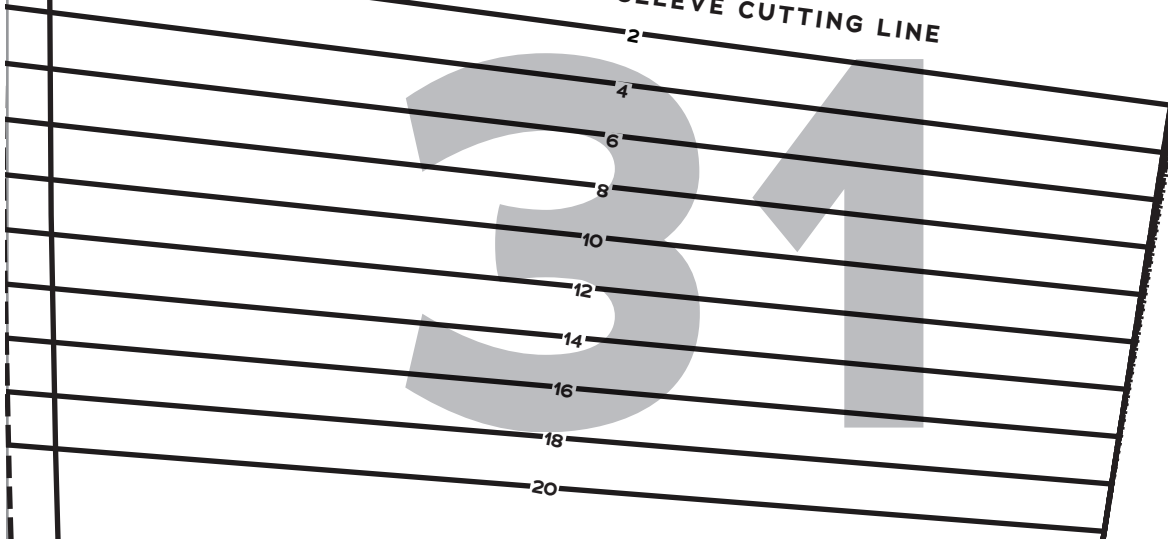

FOLD BACK THIS MARGIN

C6

FOLD BACK THIS MARGIN

C7

B7

B8



PAGE

GATHER BETWEEN NOTCHES

32

FOLD BACK THIS MARGIN

FOLD

C7



PEGGY BODICE
SIZES 2-20

1

Bodice Front,
F/G Cup
Cut 1 fabric on fold

PAGE

33

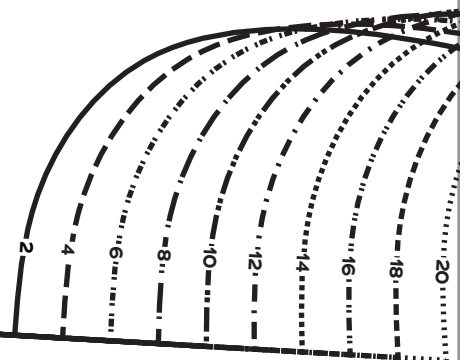
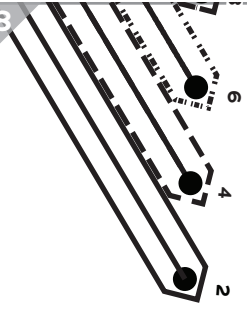

B9

B10

2

4

6

8

10

12

14

16

18

20

PAGE
34

FOLD BACK THIS MARGIN

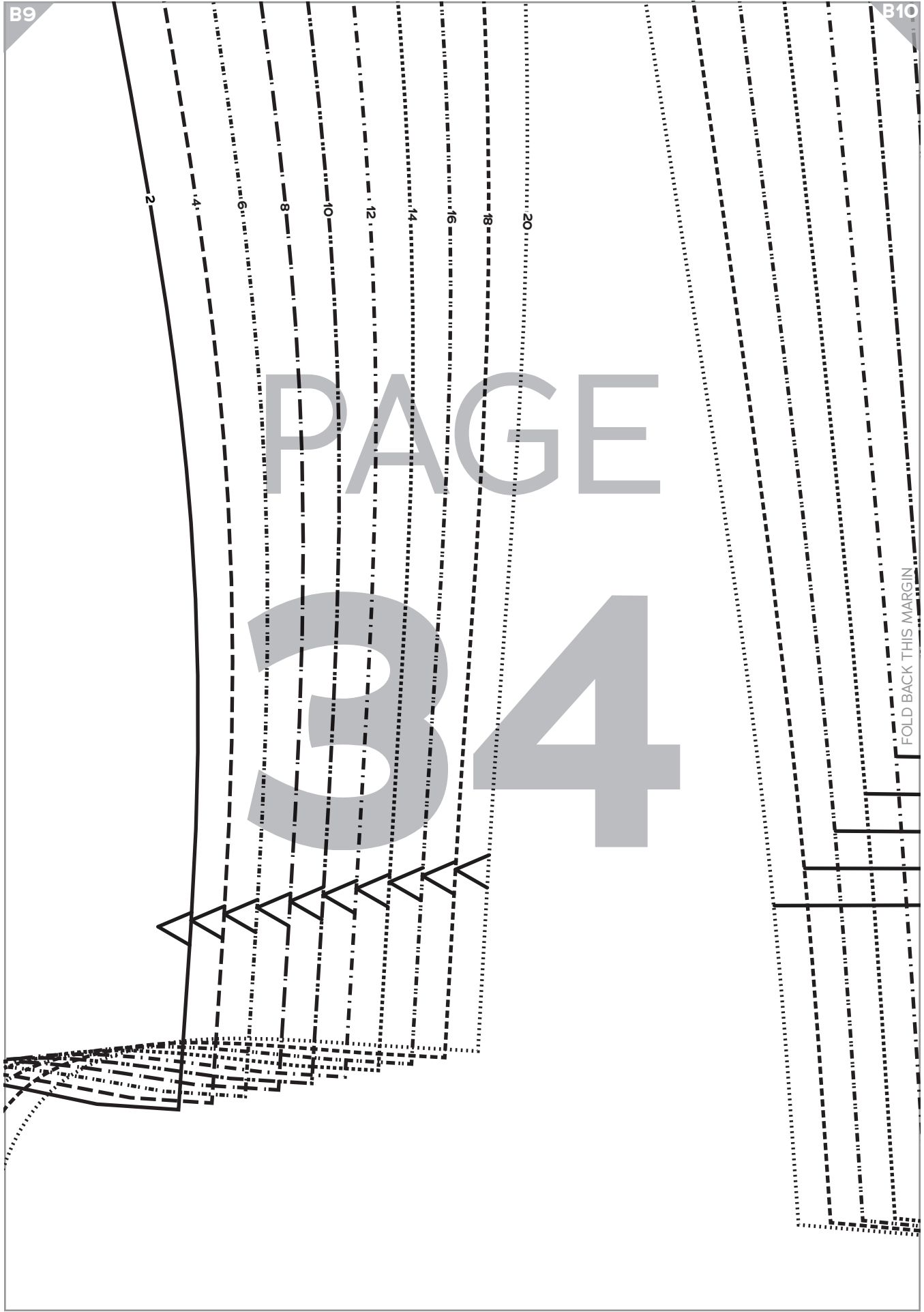

PAGE

THREE-QUARTER SLEEVE CUTTING LINE

35

FOLD BACK THIS MARGIN

- 2
- 4
- 6
- 8
- 10
- 12
- 14
- 16
- 18
- 20

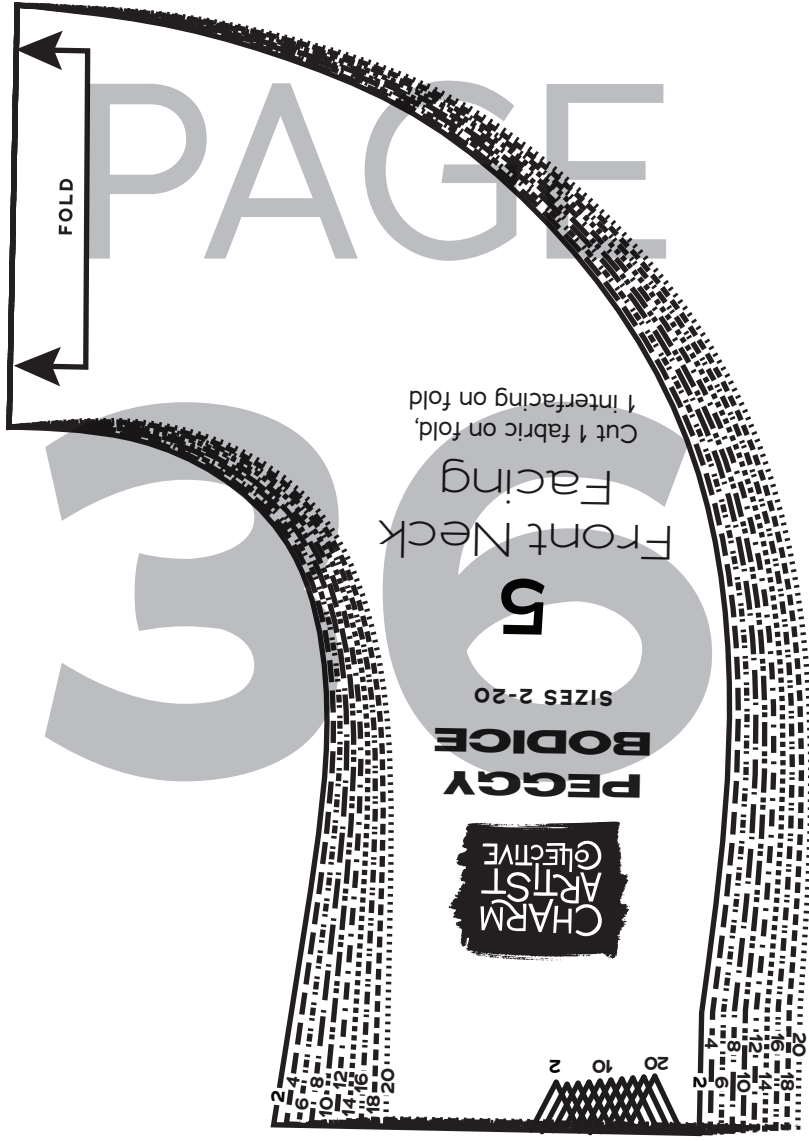

20
18
16
14
12
10
8
6
4
2

PAGE

37



FOLD BACK THIS MARGIN

20
18
16
14
12
10
8
6
4
2

PEGGY BODICE
 SIZES 2-20
2
 Bodice Back
 cut 2 fabric

PAGE

38



FOLD BACK THIS MARGIN

PAGE

39

FOLD BACK THIS MARGIN

PEGGY BODICE
SIZES 2-20



Front Underarm
Gusset
cut 2 fabric

GRAIN LINE

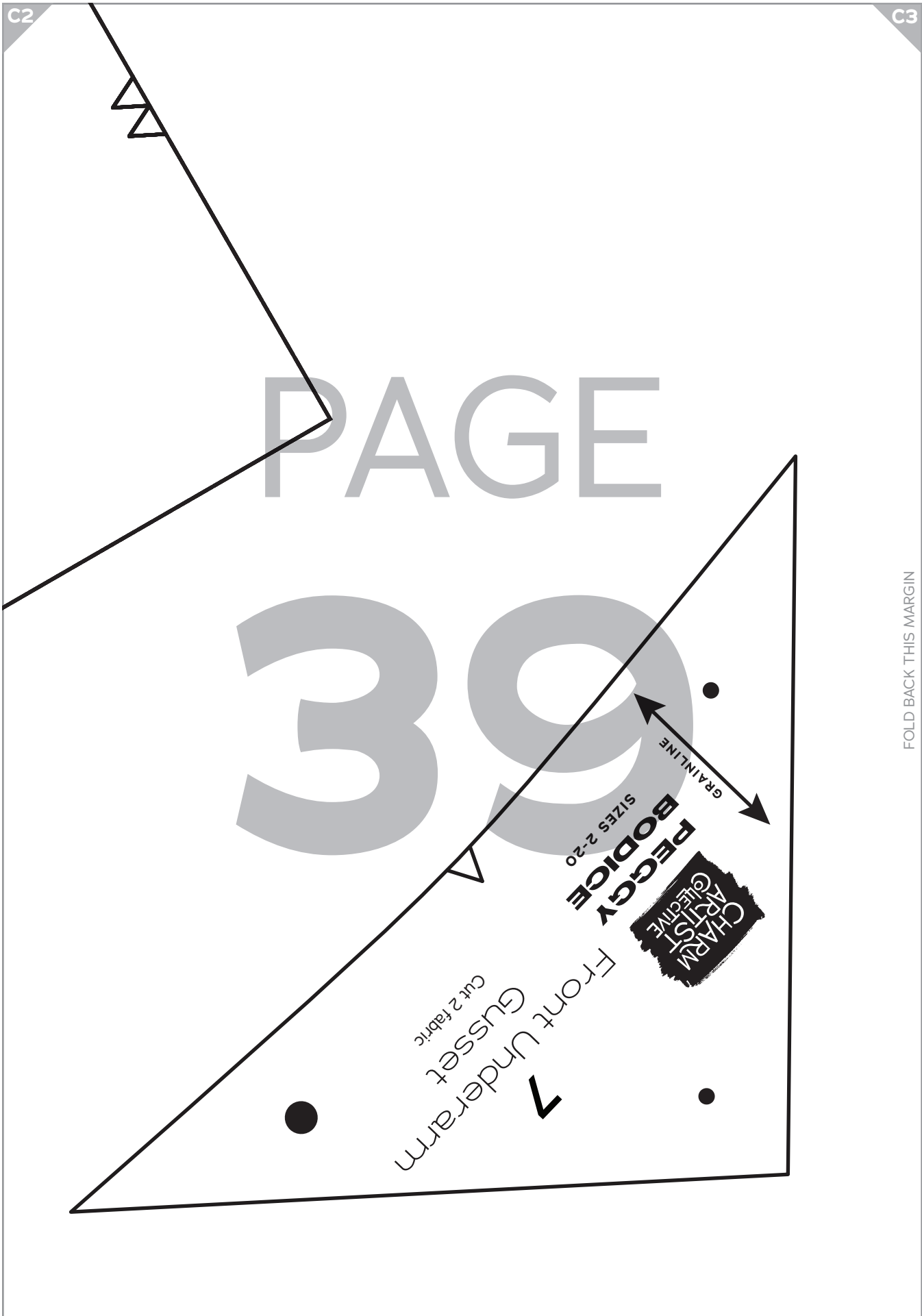

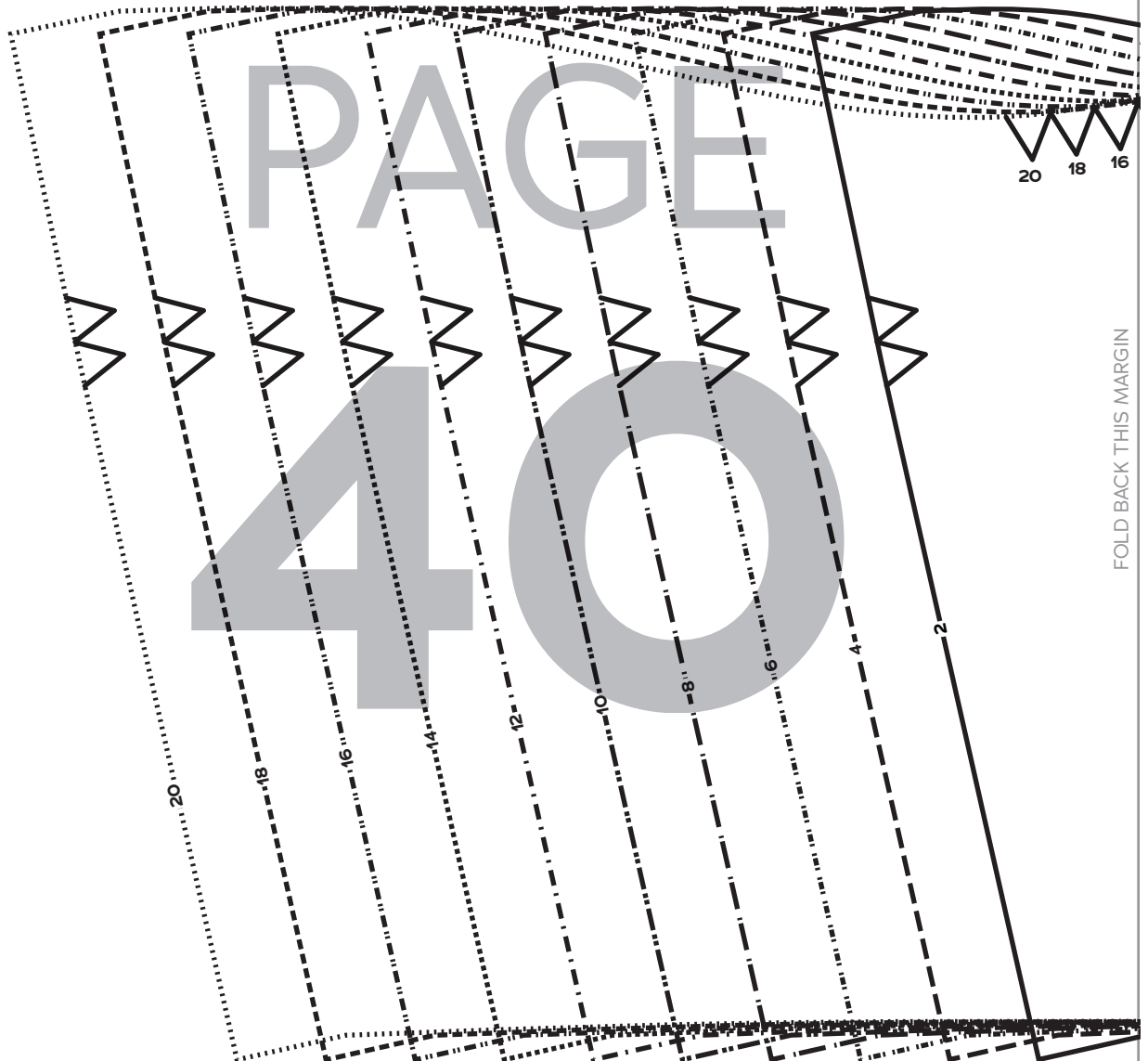

C4

C5

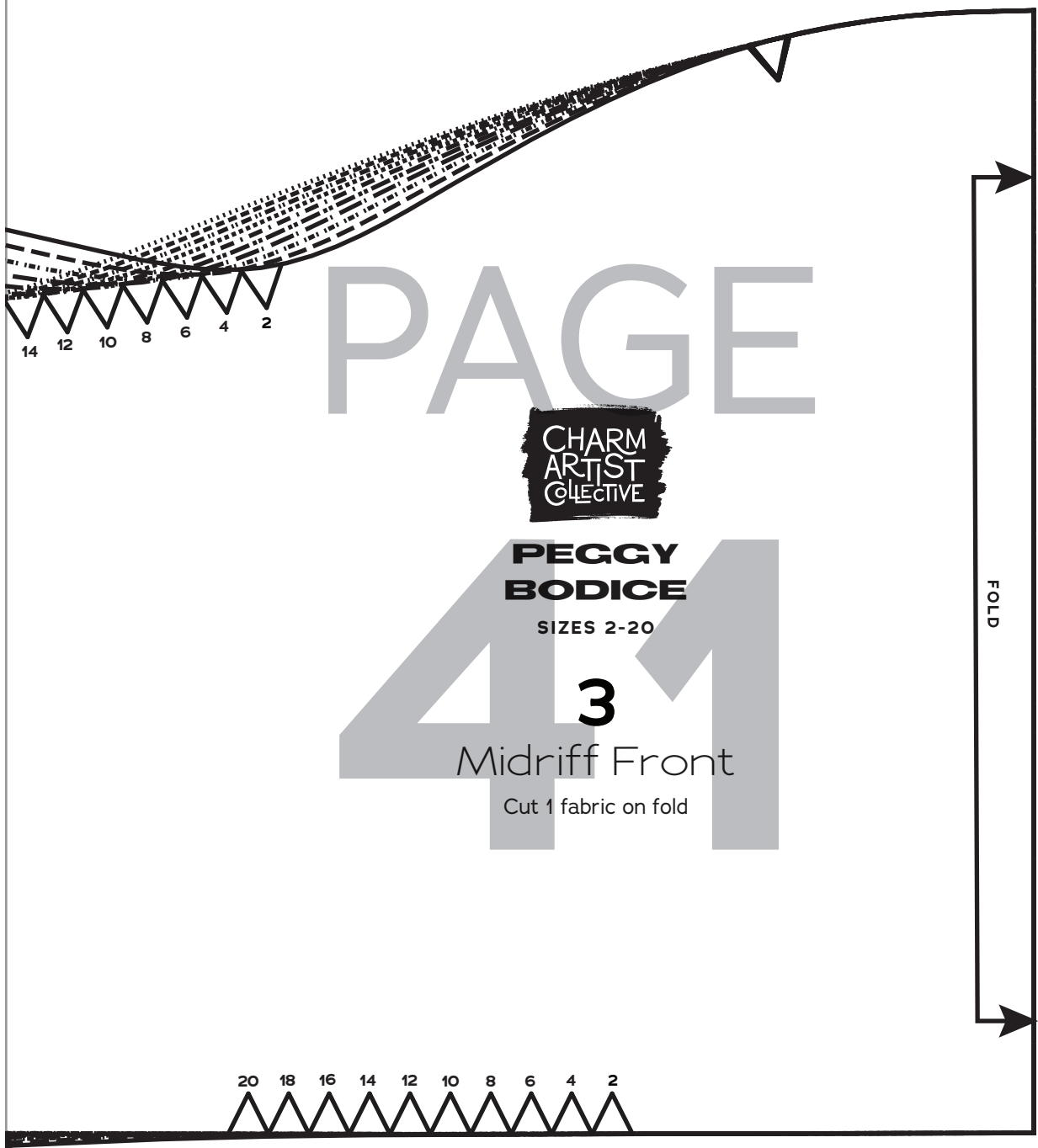

PAGE



**PEGGY
BODICE**
SIZES 2-20

41
3
Midriff Front
Cut 1 fabric on fold

FOLD BACK THIS MARGIN



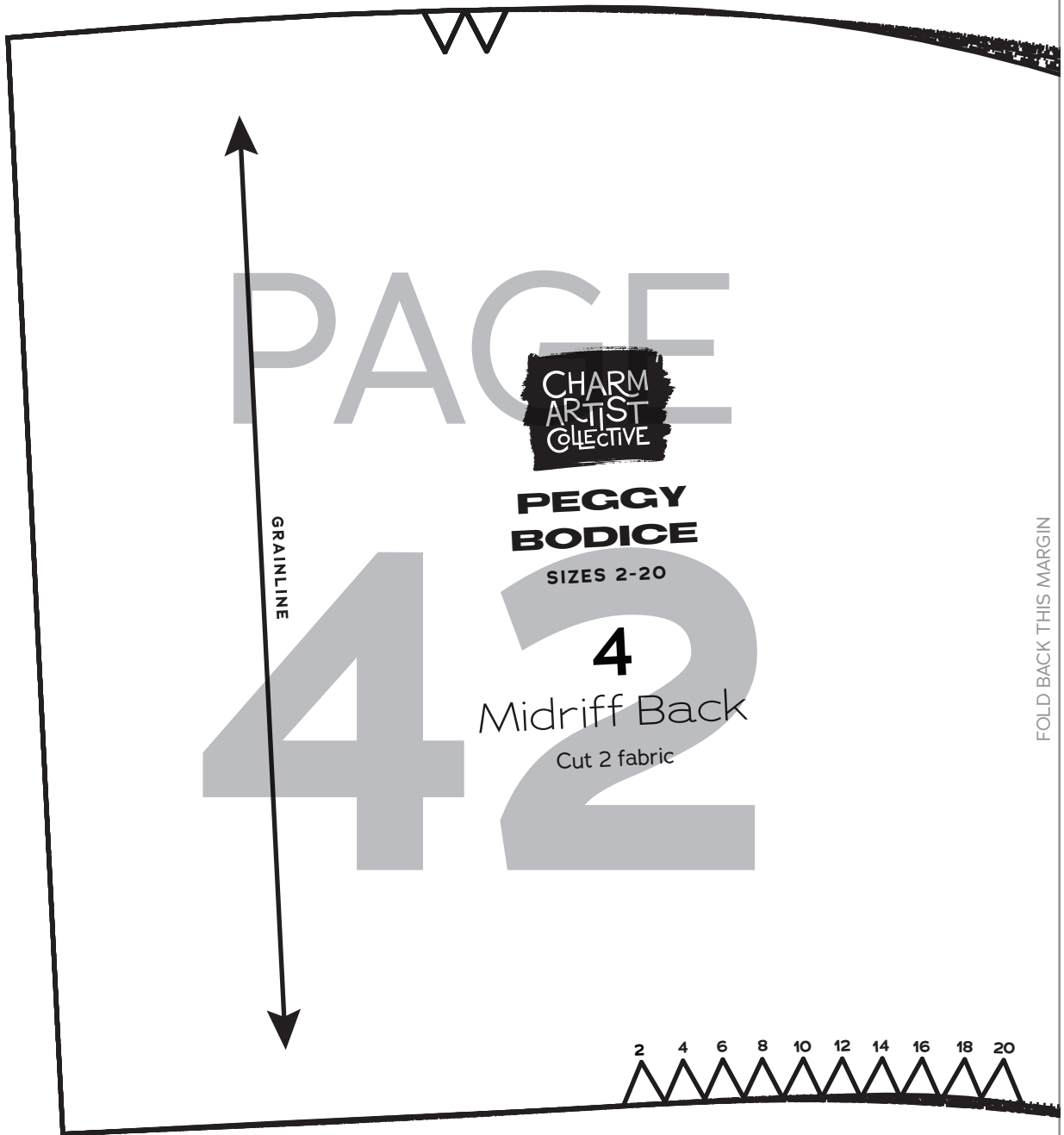

PAGE

CHARM
ARTIST
COLLECTIVE

PEGGY
BODICE

SIZES 2-20

42

4

Midriff Back

Cut 2 fabric

GRAINLINE

FOLD BACK THIS MARGIN

2 4 6 8 10 12 14 16 18 20

