



# WANDA PENCIL SKIRT

## Sizes 2-20

5/8 inch (in) (1.5 cm) seam allowances are included on all pattern pieces.

© 2022 Charm Patterns by Gertie.  
Distribution and Commercial Use Prohibited.

### SIZES 2-20 PATTERN SIZE KEY

2	—————
4	- - - - -
6	· · · · ·
8	- · - · -
10	· · · · ·
12	- · - · -
14	· · · · ·
16	- · - · -
18	· · · · ·
20	- · - · -

### SYMBOL KEY

grainline arrow



match point/  
placement mark

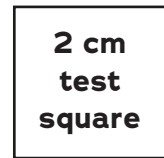
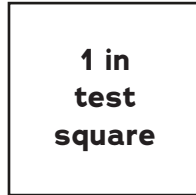

# PAGE

# 1

FOLD BACK THIS MARGIN

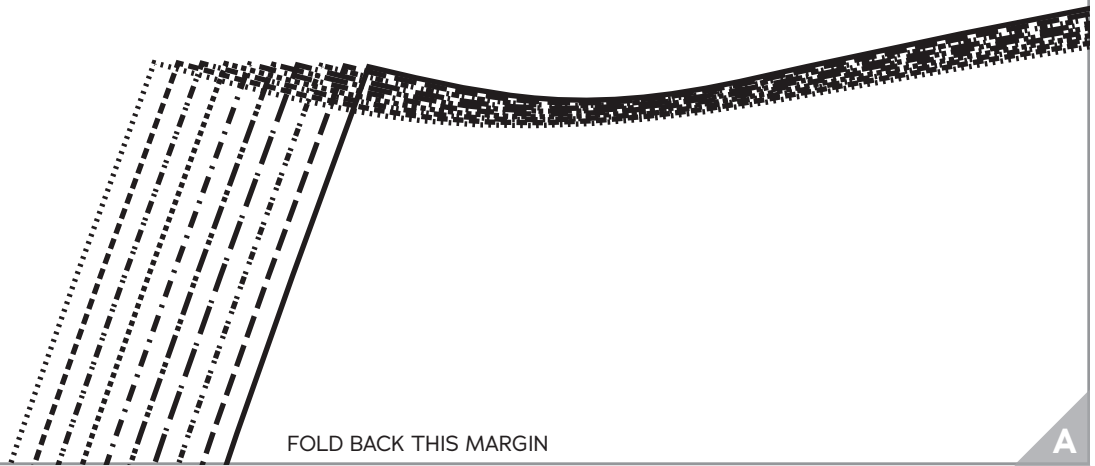

FOLD BACK THIS MARGIN

A

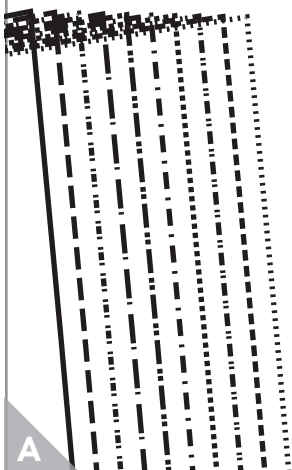
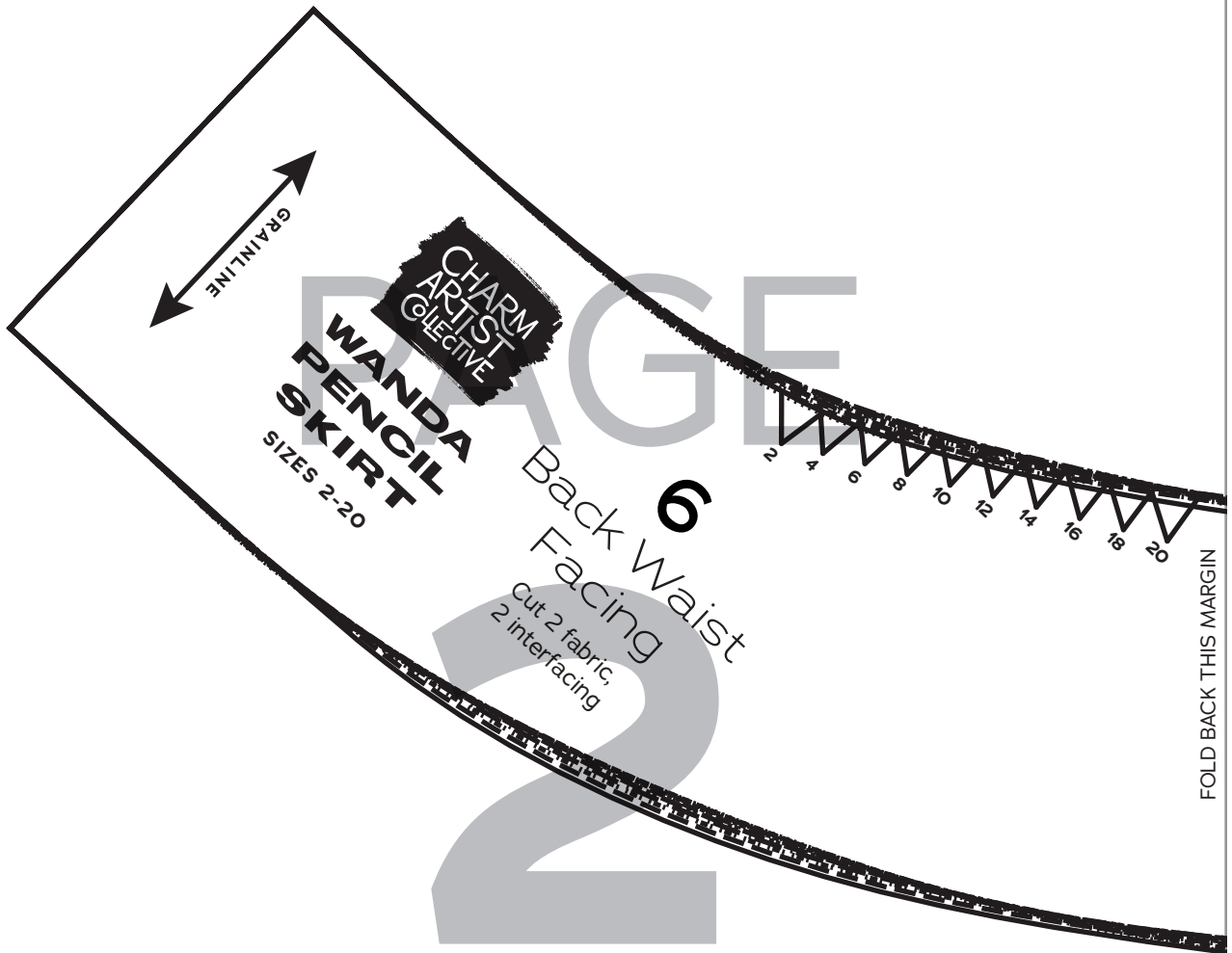

FOLD BACK THIS MARGIN

# PAGE

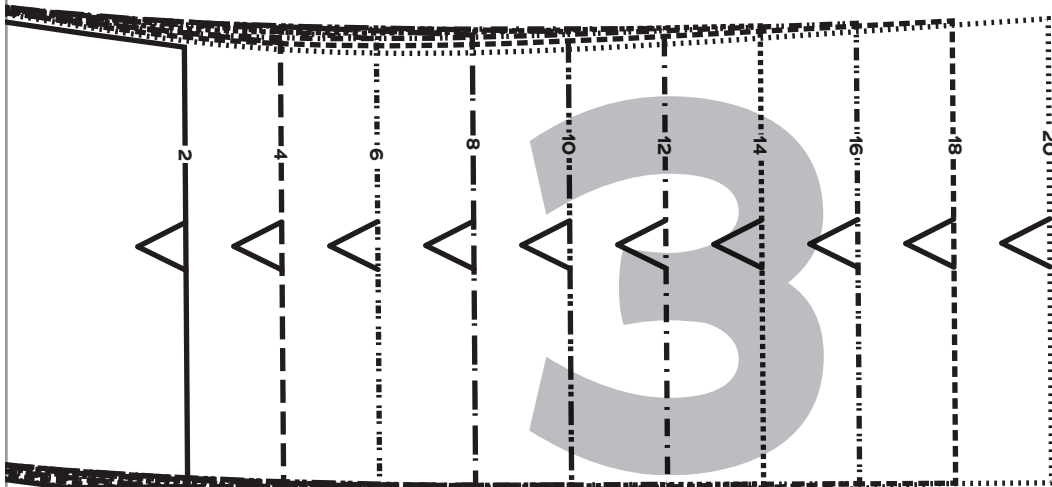

FOLD BACK THIS MARGIN



FOLD BACK THIS MARGIN

# PAGE

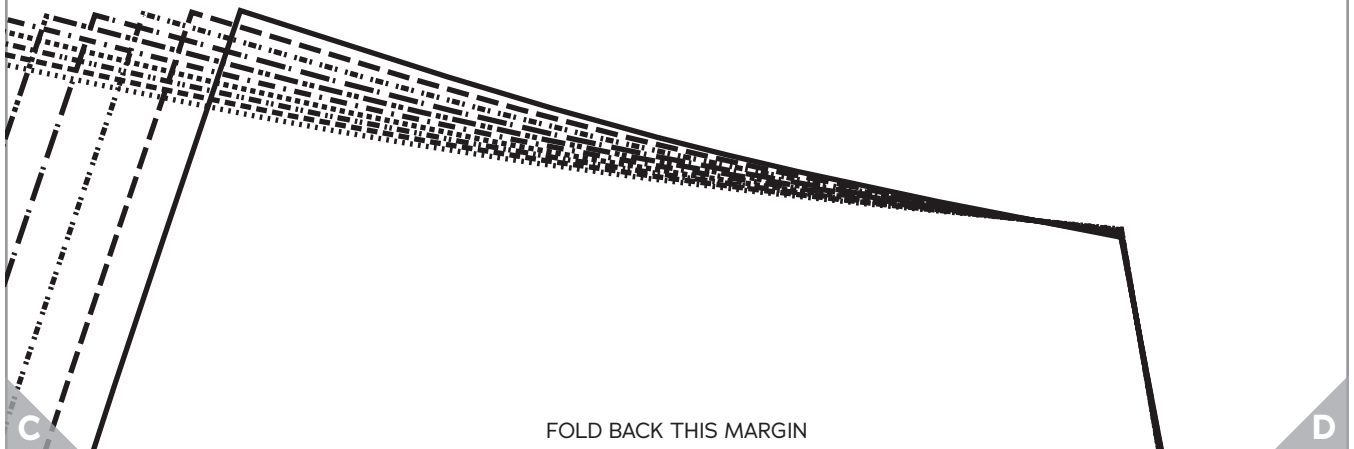
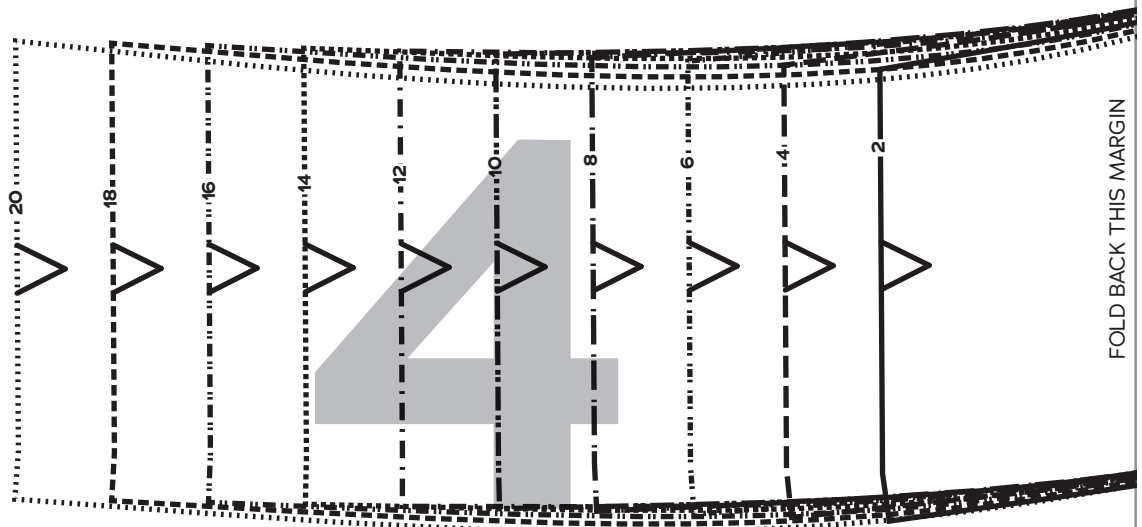

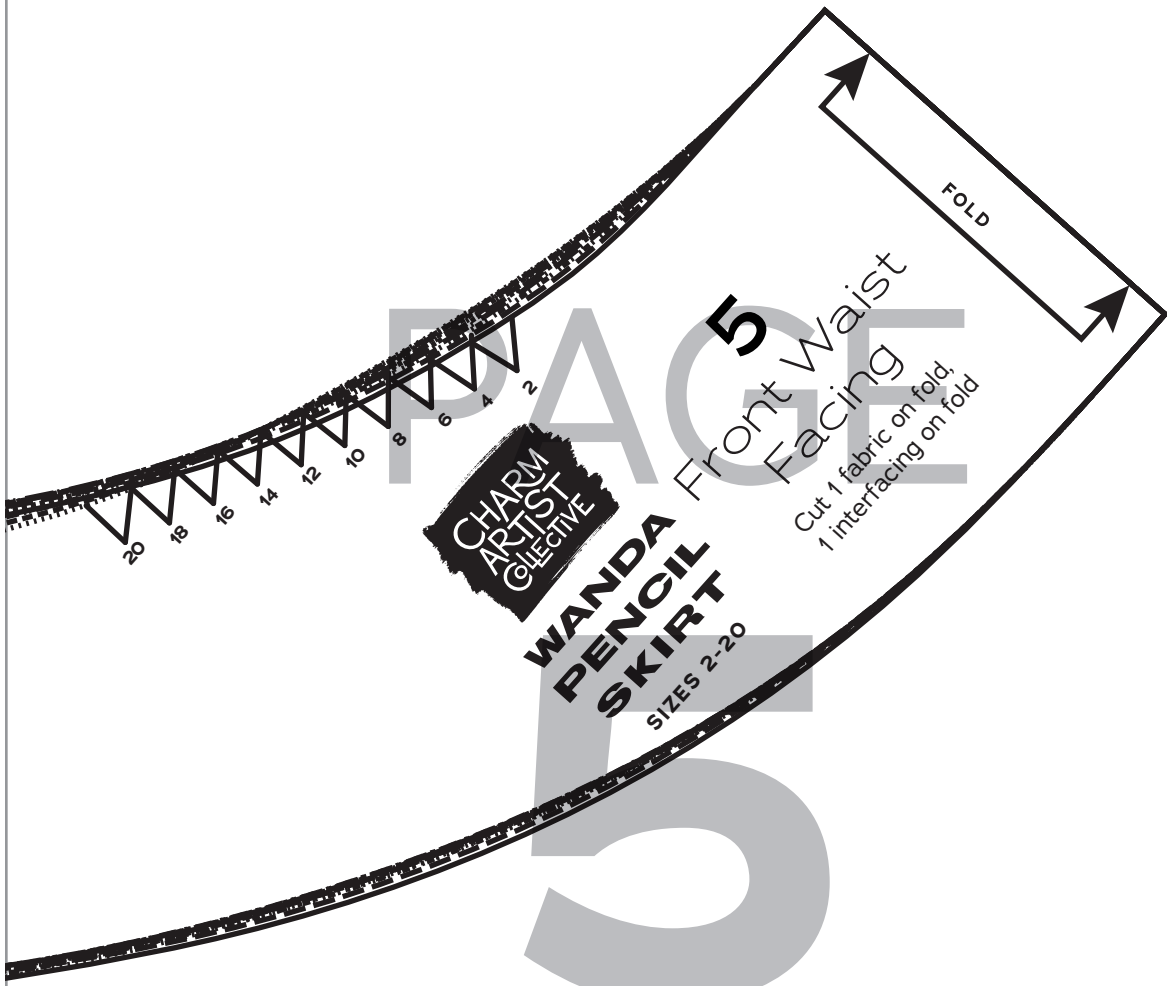

CHARM  
ARTIST  
COLLECTIVE

WANDA  
PENCIL  
SKIRT  
SIZES 2-20

5  
Front Waist  
Facing  
Cut 1 fabric on fold,  
1 interfacing on fold

FOLD

D

FOLD BACK THIS MARGIN

A

PAGE

6

FOLD BACK THIS MARGIN

20  
18  
16  
14  
12  
10  
8  
6  
4  
2

LENGTH ADJUSTMENT LINE

FOLD BACK THIS MARGIN

E

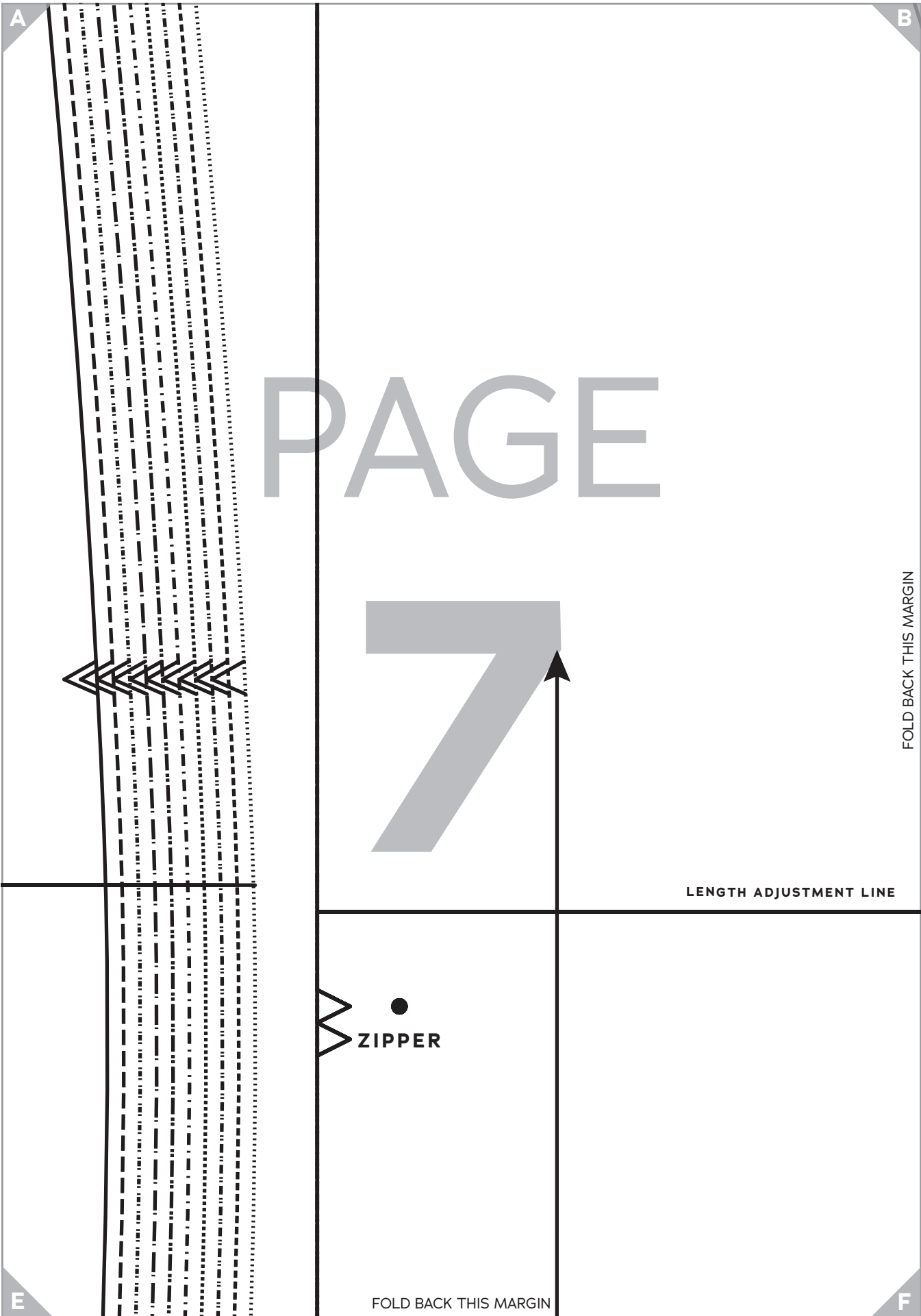

PAGE

7

FOLD BACK THIS MARGIN

LENGTH ADJUSTMENT LINE

ZIPPER

FOLD BACK THIS MARGIN

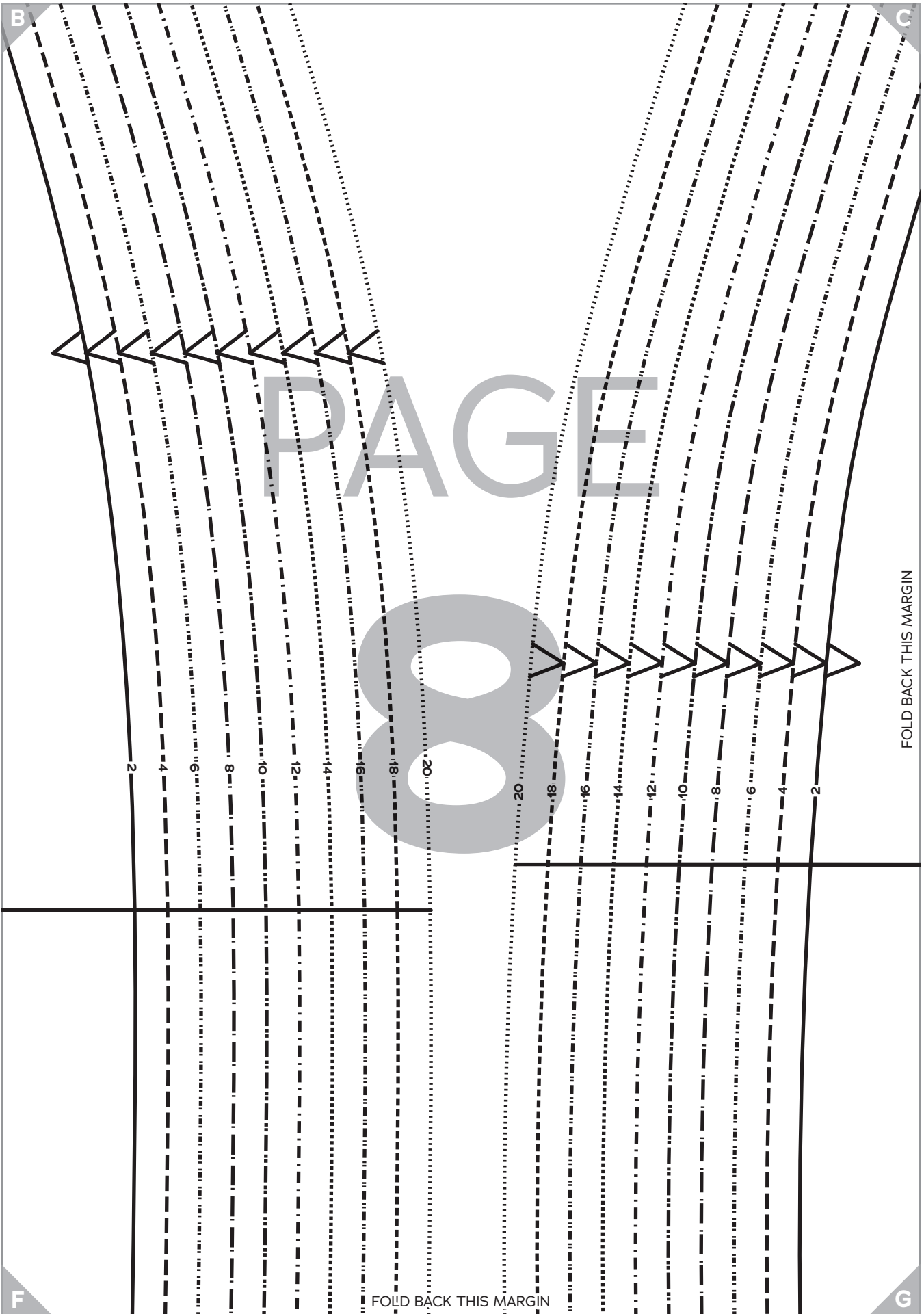



# PAGE

# 9

LENGTH ADJUSTMENT LINE

THIGH SLIT  
ZIPPER

- 2 ●
- 4 ●
- 6 ●
- 8 ●
- 10 ●
- 12 ●
- 14 ●
- 16 ●
- 18 ●
- 20 ●

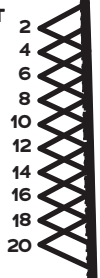

FOLD BACK THIS MARGIN

FOLD BACK THIS MARGIN

D

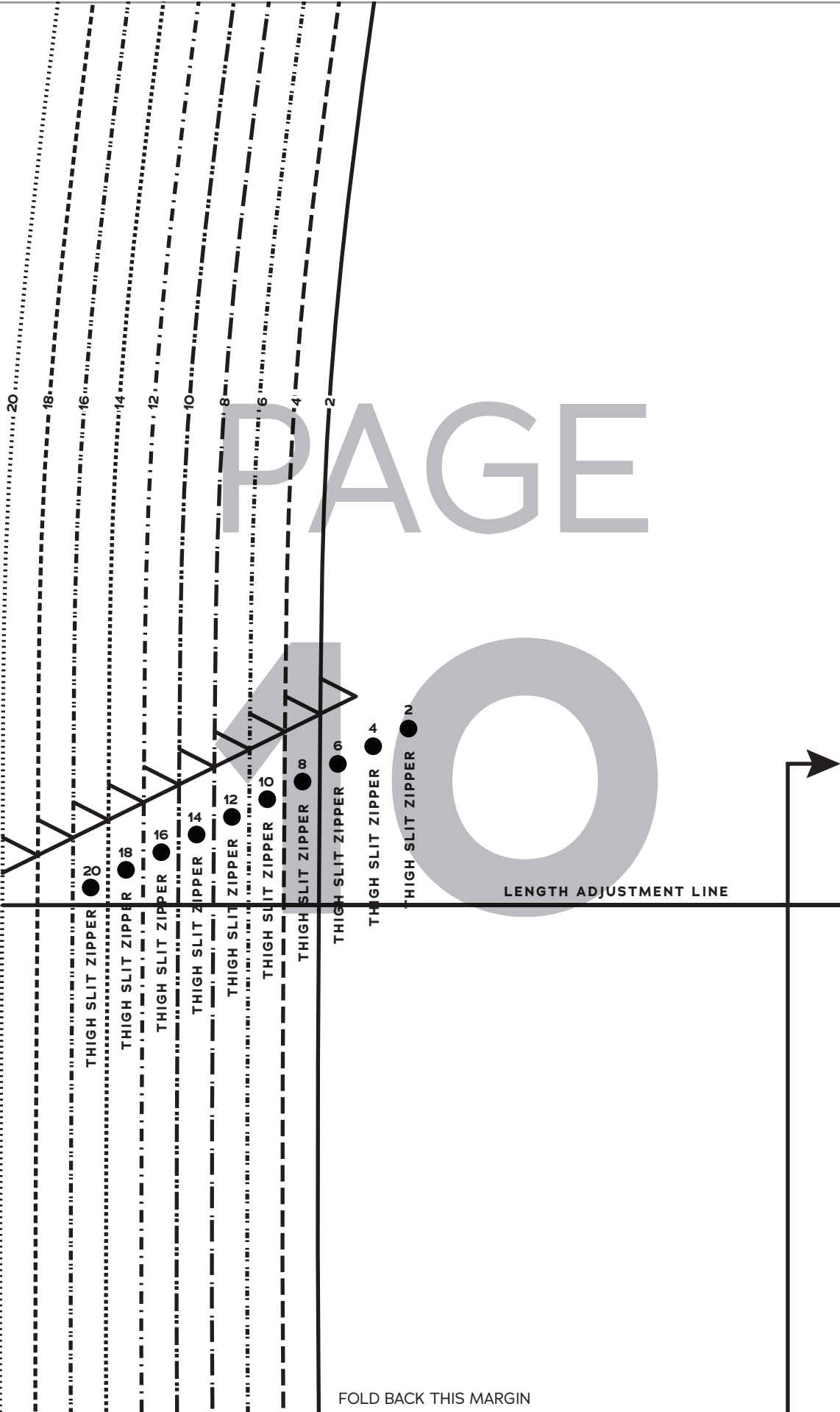

PAGE

O

LENGTH ADJUSTMENT LINE

FOLD BACK THIS MARGIN

H



# WANDA PENCIL SKIRT

SIZES 2-20

## 4

Skirt Side  
Back

Cut 2 fabric, 2 lining

# PAGE

# 11

GRAINLINE

FOLD BACK THIS MARGIN

FOLD BACK THIS MARGIN

E

F



# WANDA PENCIL SKIRT

SIZES 2-20

## 3

### Skirt Center Back

Cut 2 fabric, 2 lining

# PAGE

# 12

GRAINLINE

FOLD BACK THIS MARGIN

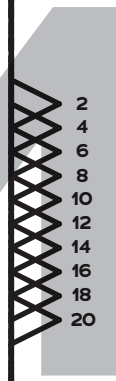
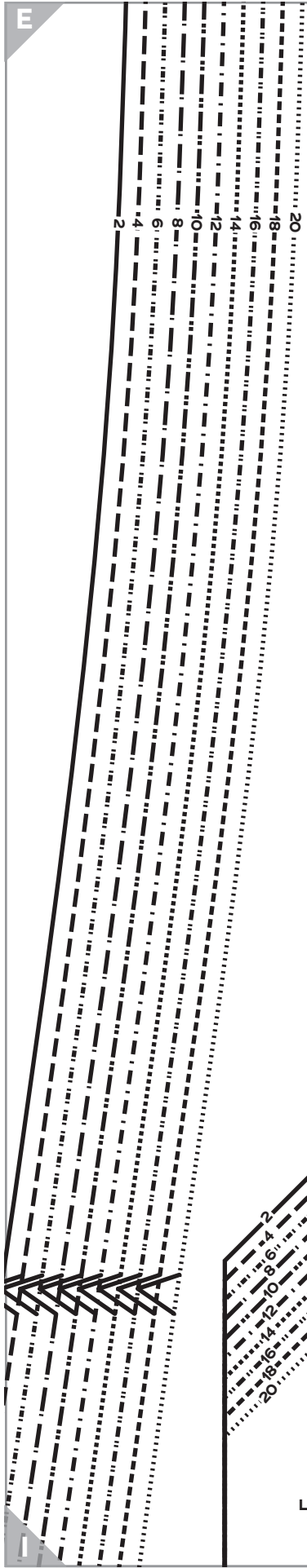

UPPER VENT



LOWER VENT

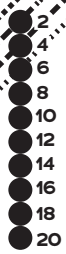

LOWER VENT (LEFT LINING ONLY)



FOLD BACK THIS MARGIN

F

G

PAGE  
13

FOLD BACK THIS MARGIN



J

FOLD BACK THIS MARGIN

K

G

H

GRAINLINE



# WANDA PENCIL SKIRT

SIZES 2-20

## 2

Skirt Side  
Front

Cut 2 fabric, 2 lining

# PAGE

# 14

THIGH SLIT

- 2 ●
- 4 ●
- 6 ●
- 8 ●
- 10 ●
- 12 ●
- 14 ●
- 16 ●
- 18 ●
- 20 ●

FOLD BACK THIS MARGIN



K

L

FOLD BACK THIS MARGIN

H



# WANDA PENCIL SKIRT

SIZES 2-20

1

## Skirt Center Front

Cut 1 fabric on fold,  
1 lining on fold

PAGE

15

THIGH SLIT ● 20

THIGH SLIT ● 18

THIGH SLIT ● 16

THIGH SLIT ● 14

THIGH SLIT ● 12

THIGH SLIT ● 10

THIGH SLIT ● 8

THIGH SLIT ● 6

THIGH SLIT ● 4

THIGH SLIT ● 2

FOLD



FOLD BACK THIS MARGIN

PAGE

16

FOLD BACK THIS MARGIN

- 2
- 4
- 6
- 8
- 10
- 12
- 14
- 16
- 18
- 20



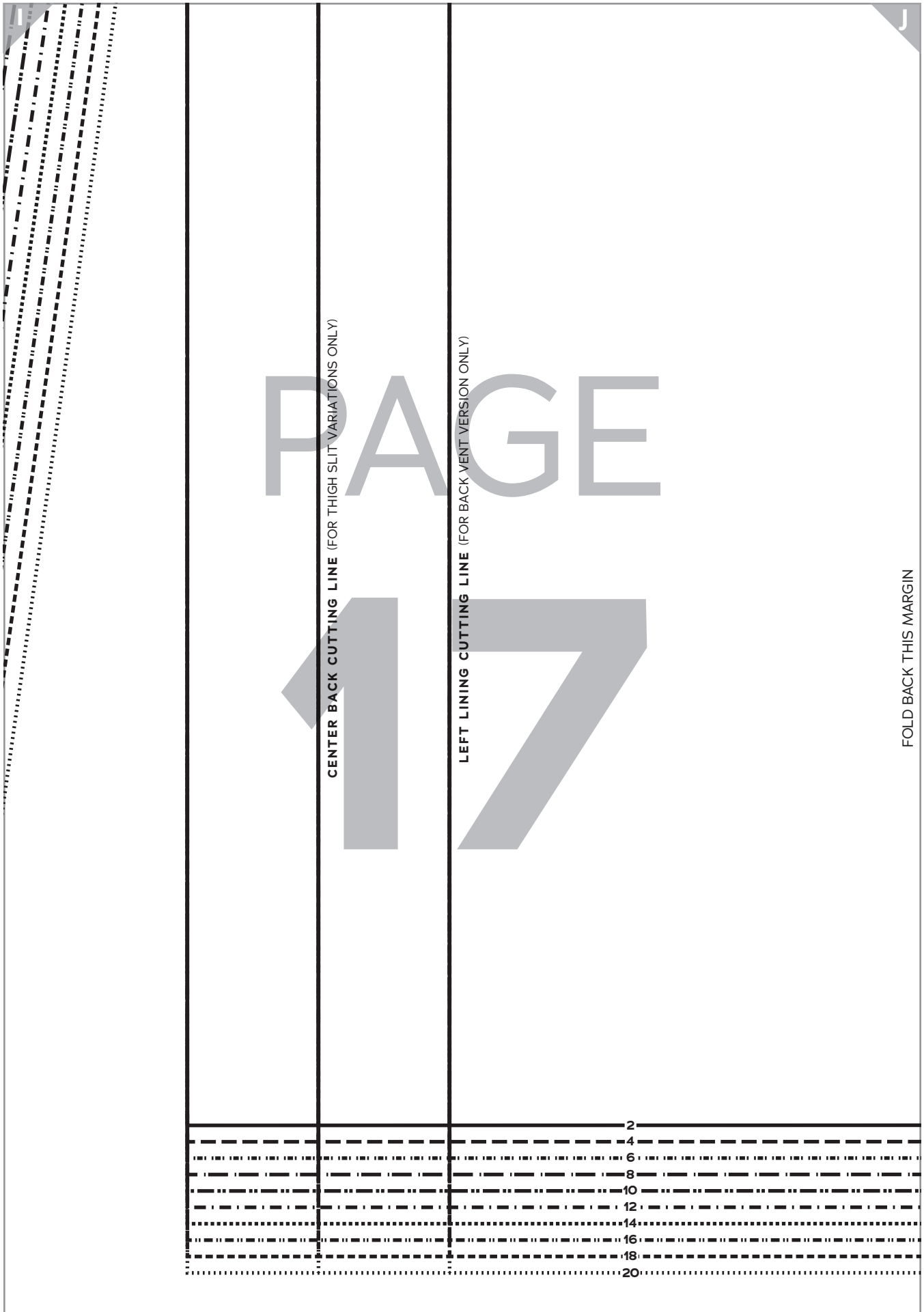

CENTER BACK CUTTING LINE (FOR THIGH SLIT VARIATIONS ONLY)

LEFT LINING CUTTING LINE (FOR BACK VENT VERSION ONLY)

FOLD BACK THIS MARGIN

2  
4  
6  
8  
10  
12  
14  
16  
18  
20

J

K

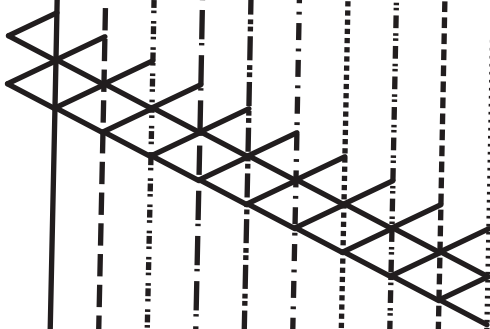

# PAGE 18

FOLD BACK THIS MARGIN

K

L

# PAGE

# 19

FOLD BACK THIS MARGIN

2	.....
4	.....
6	.....
8	.....
10	.....
12	.....
14	.....
16	.....
18	.....
20	.....

L

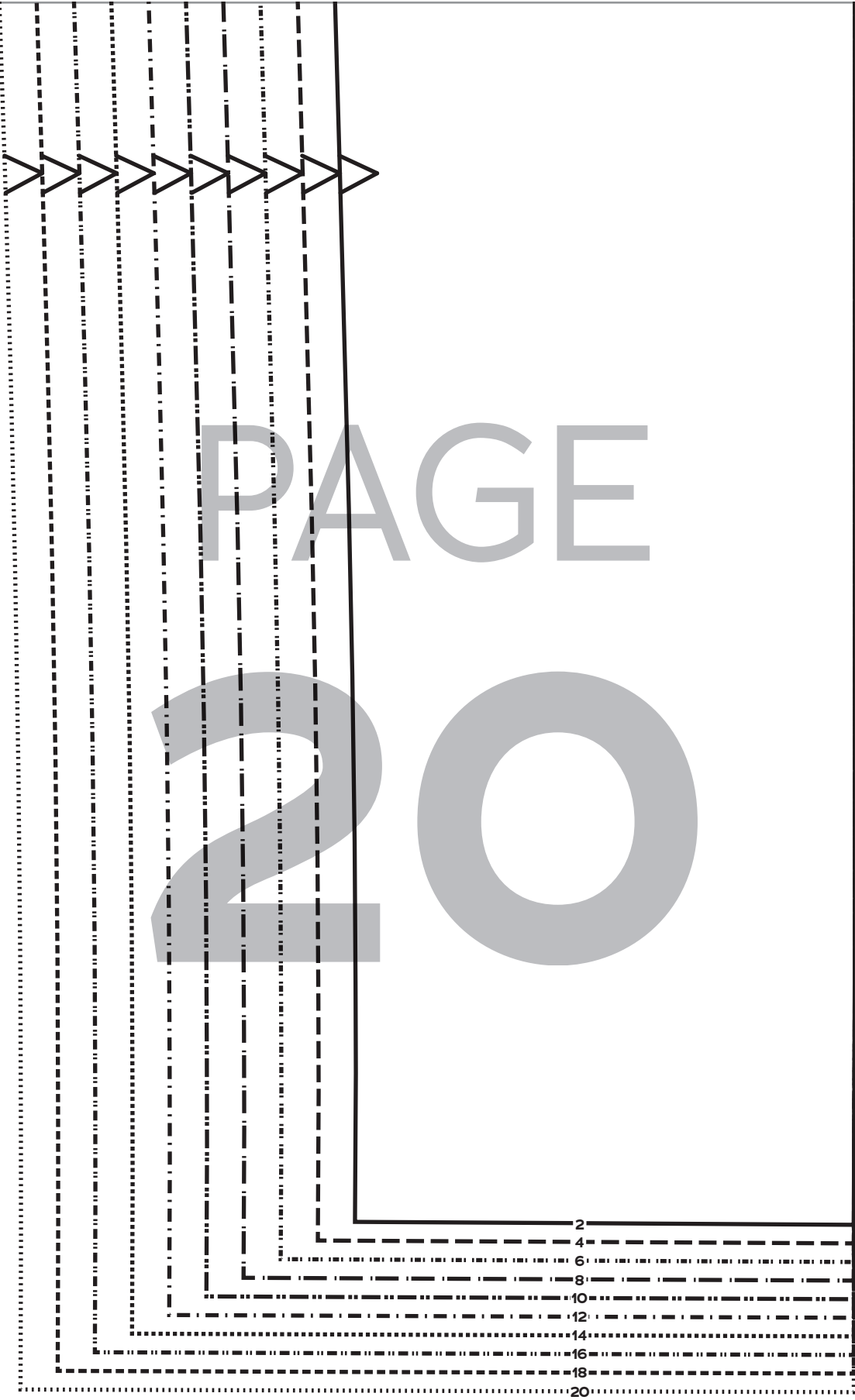

PAGE

20

2  
4  
6  
8  
10  
12  
14  
16  
18  
20