



Scout Dress

Sizes 2-20
with cup sizes A-H

5/8 inch (in) (1.5 cm) seam allowances are included on all pattern pieces.

SIZES 2-20 PATTERN SIZE KEY

2	—————
4	- - - - -
6	· · · · ·
8	- · - · -
10	- · - · - · -
12	- · - · - · - · -
14	· · · · ·
16	- · - · - · - · -
18	- - - - -
20	· · · · ·

SYMBOL KEY

grainline arrow



match point/
placement mark

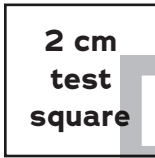
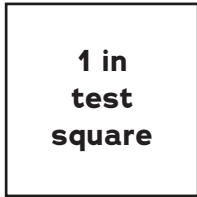

PAGE

© 2023 Charm Patterns by Gertie. Distribution and Commercial Use Prohibited.

1

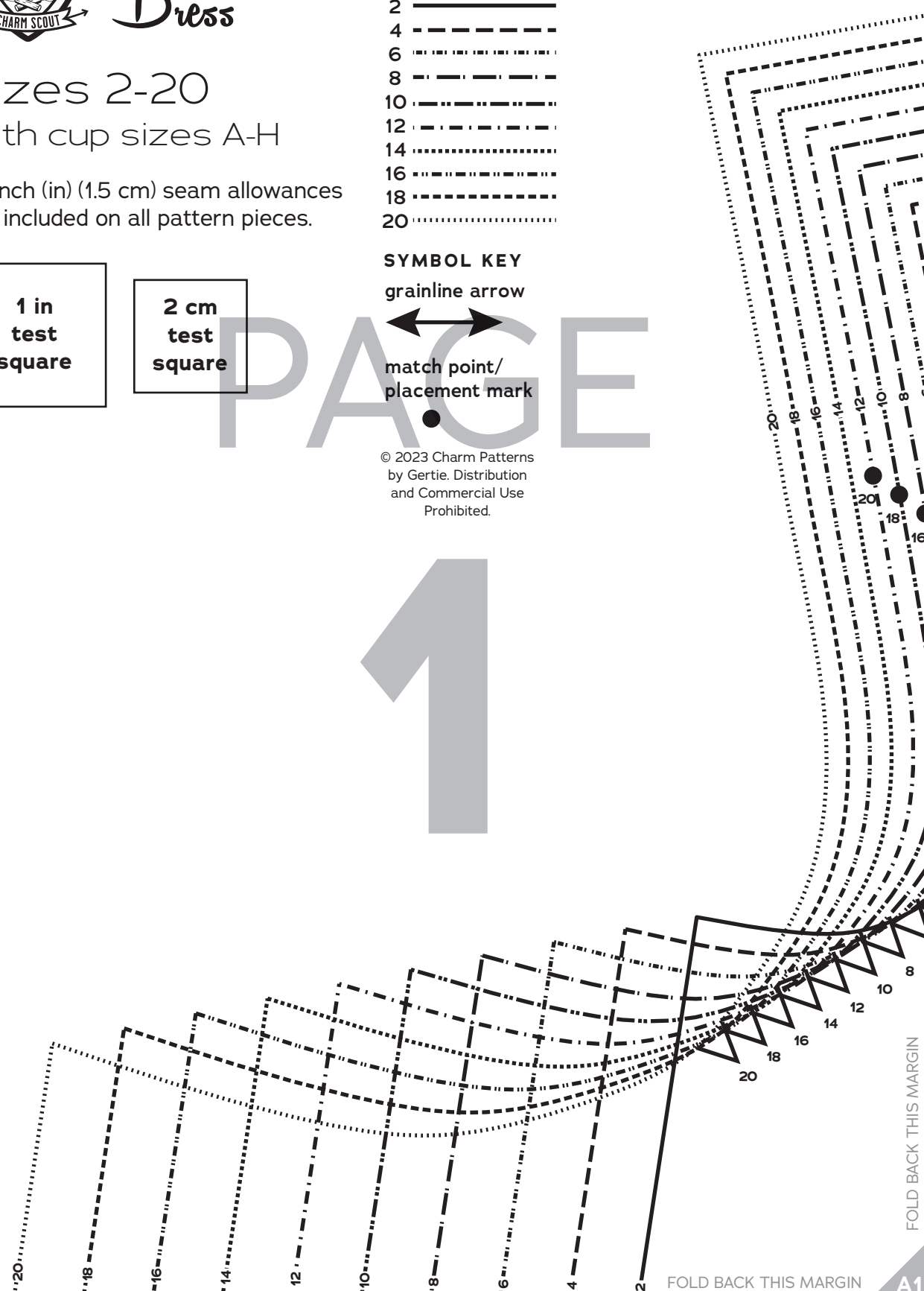

FOLD BACK THIS MARGIN

FOLD BACK THIS MARGIN

A1

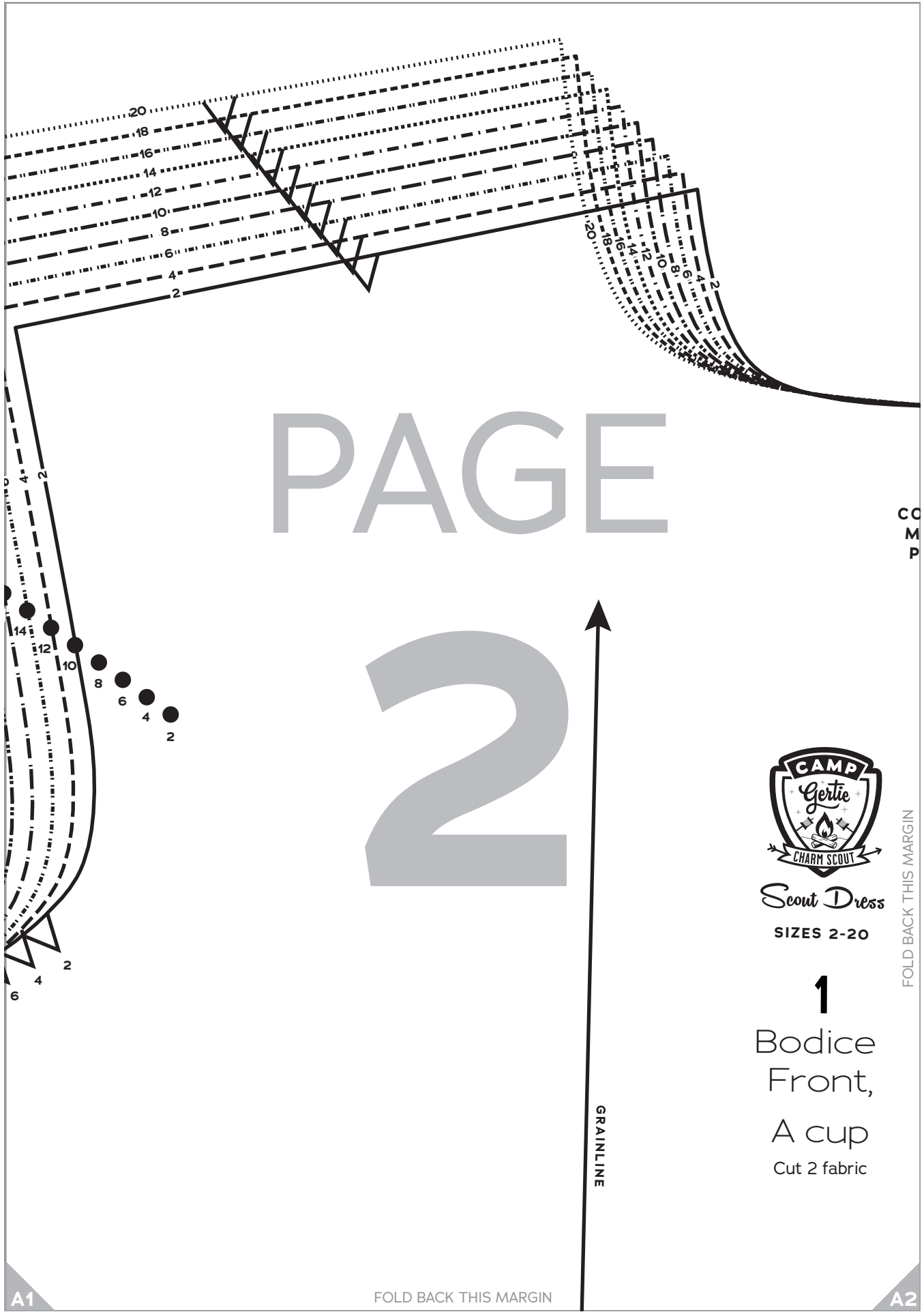

PAGE

2

CO
M
P



Scout Dress
SIZES 2-20

FOLD BACK THIS MARGIN

1
Bodice
Front,
A cup
Cut 2 fabric

GRAINLINE

A1

FOLD BACK THIS MARGIN

A2

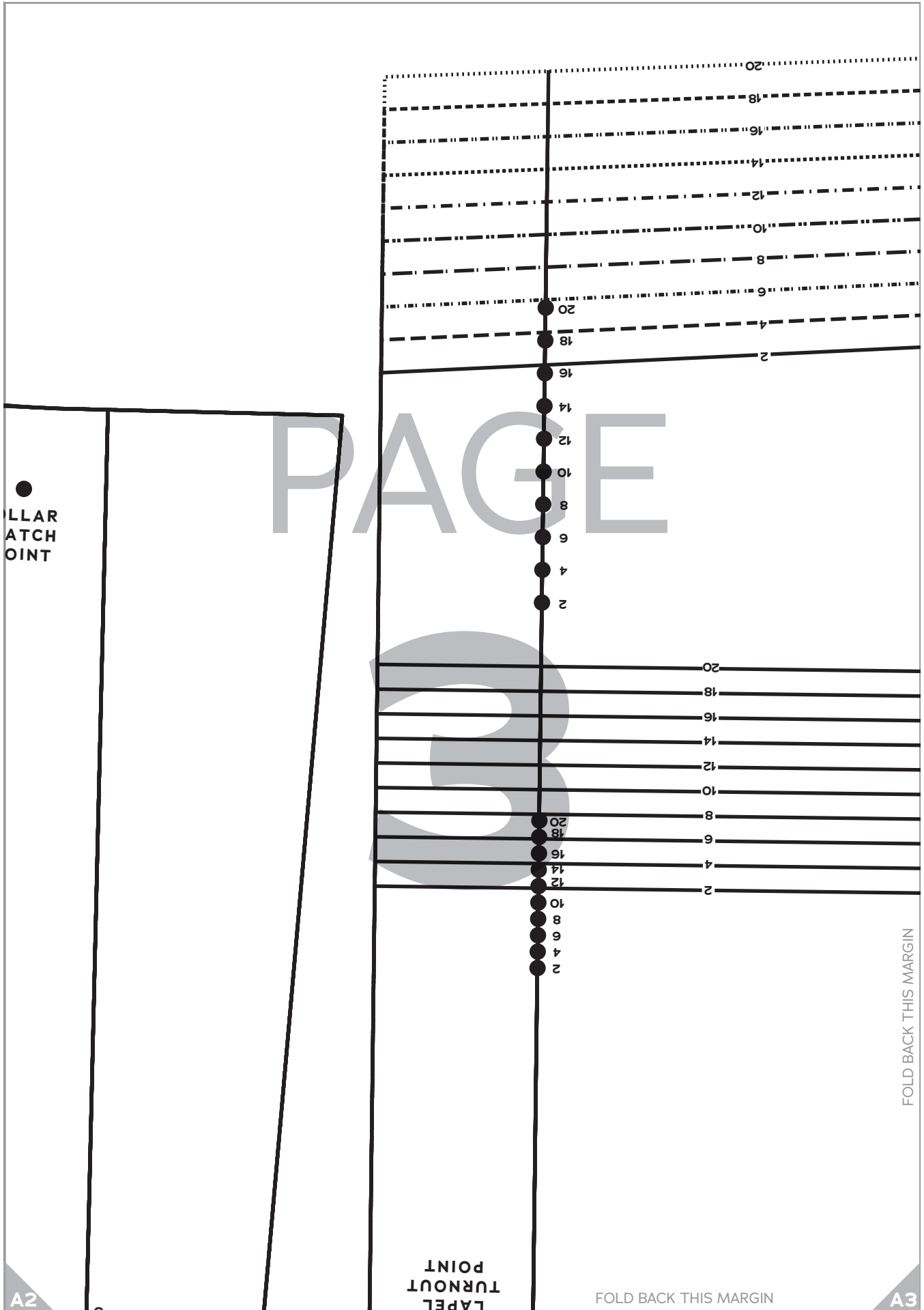

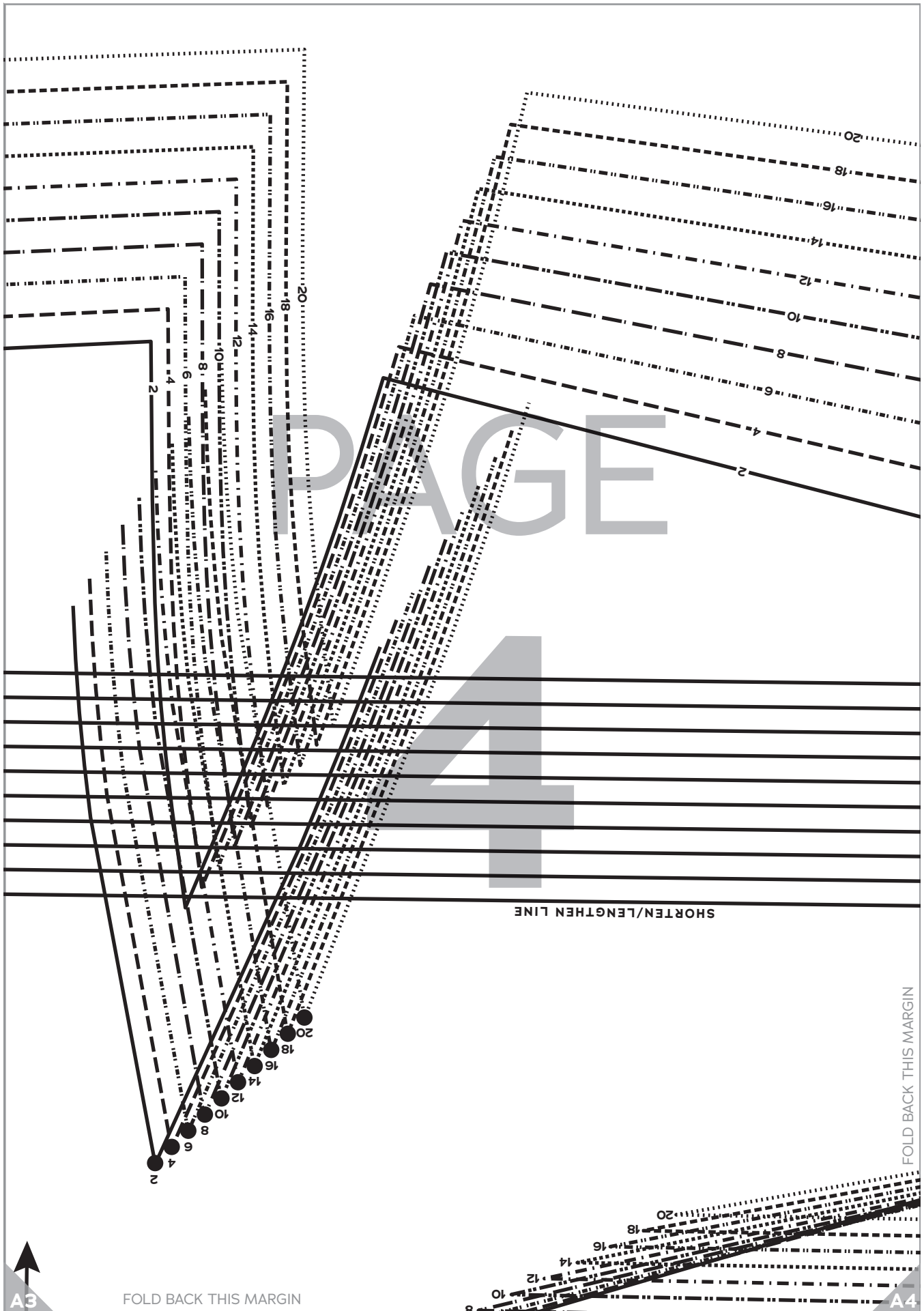

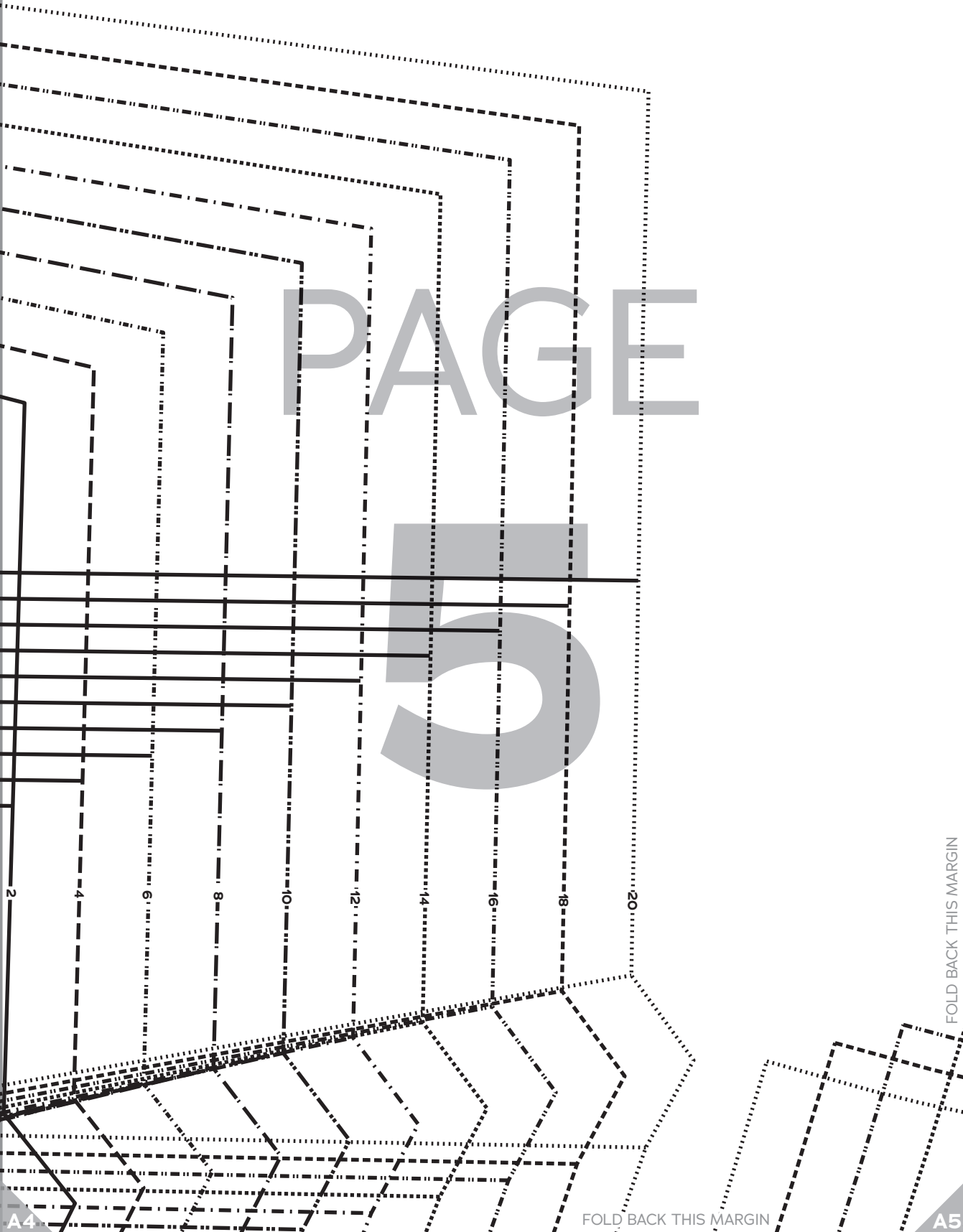

PAGE
5

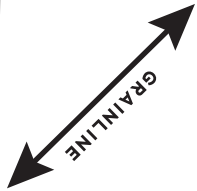

FOLD BACK THIS MARGIN

FOLD BACK THIS MARGIN





Scout Dress

SIZES 2-20

8

Sleeve Keyhole Binding

 Cut 2 fabric

PAGE 6

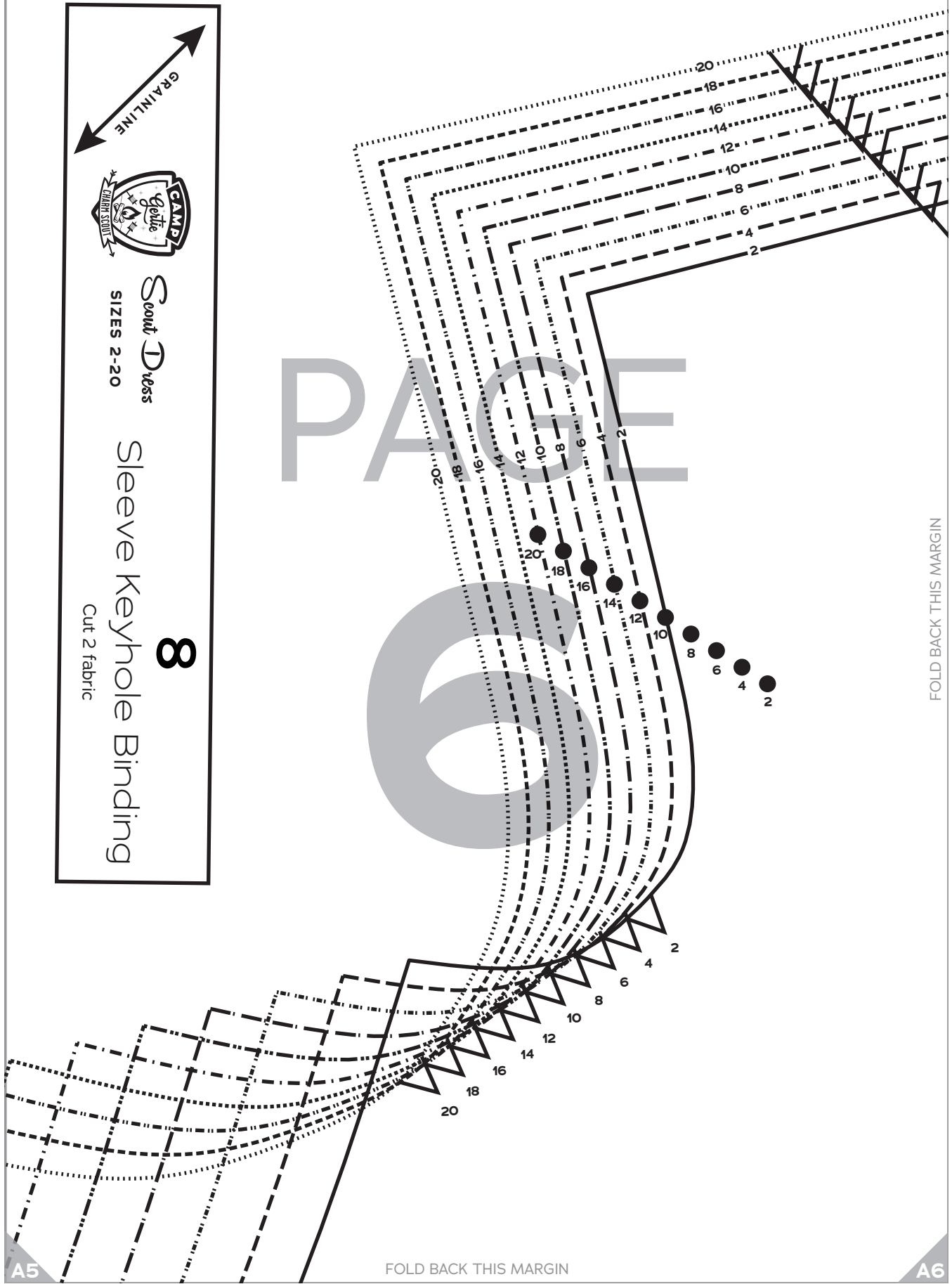

A5

FOLD BACK THIS MARGIN

A6

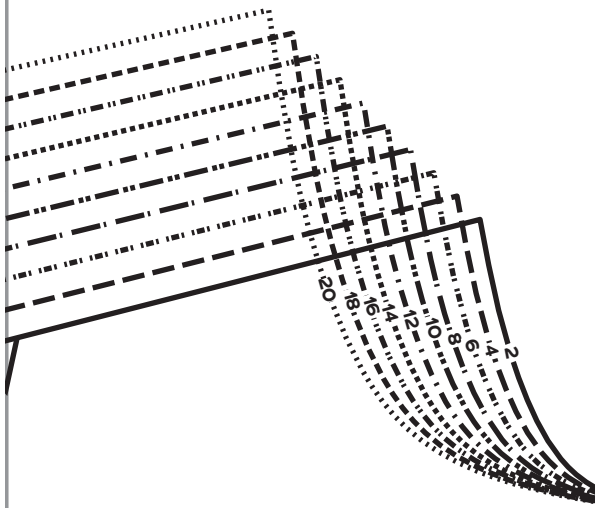

PAGE

COLLAR MATCH POINT

7



Scout Dress
SIZES 2-20

1

Bodice
Front,
D/DD Cup
Cut 2 fabric

GRAINLINE

FOLD BACK THIS MARGIN

CENTER F

A6

FOLD BACK THIS MARGIN

A7

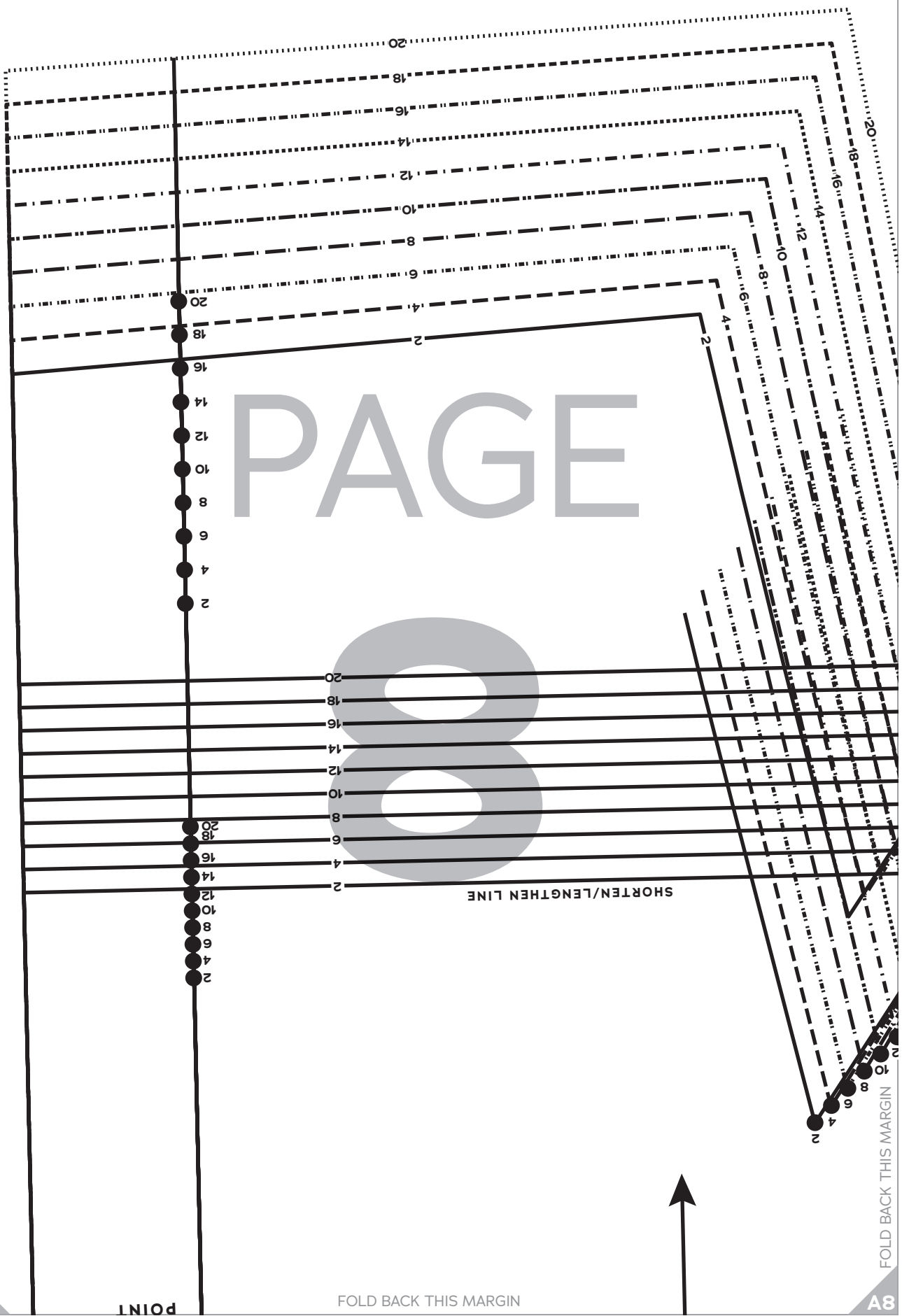

PAGE
9

FOLD BACK THIS MARGIN

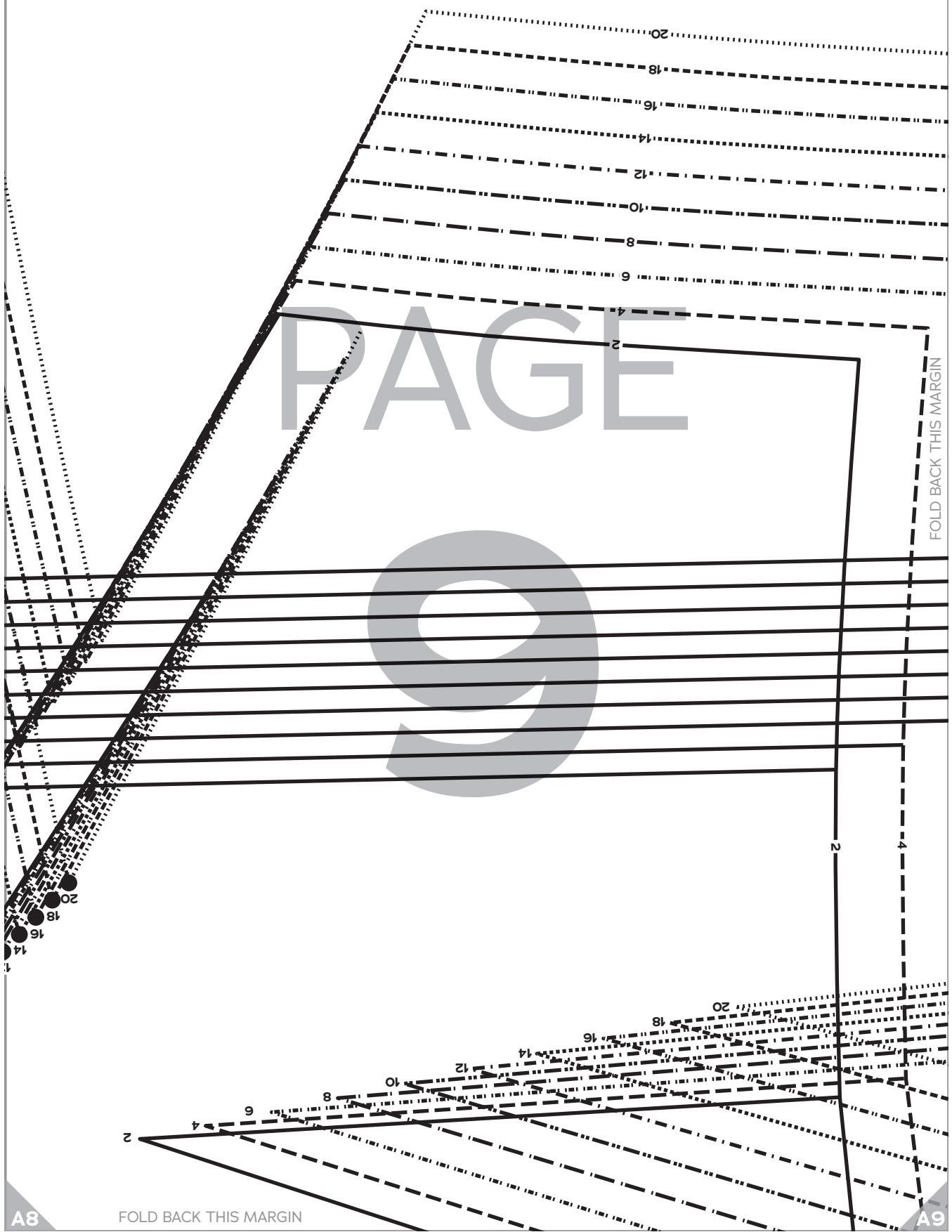

A8

FOLD BACK THIS MARGIN

A9

PAGE

10

FOLD BACK THIS MARGIN

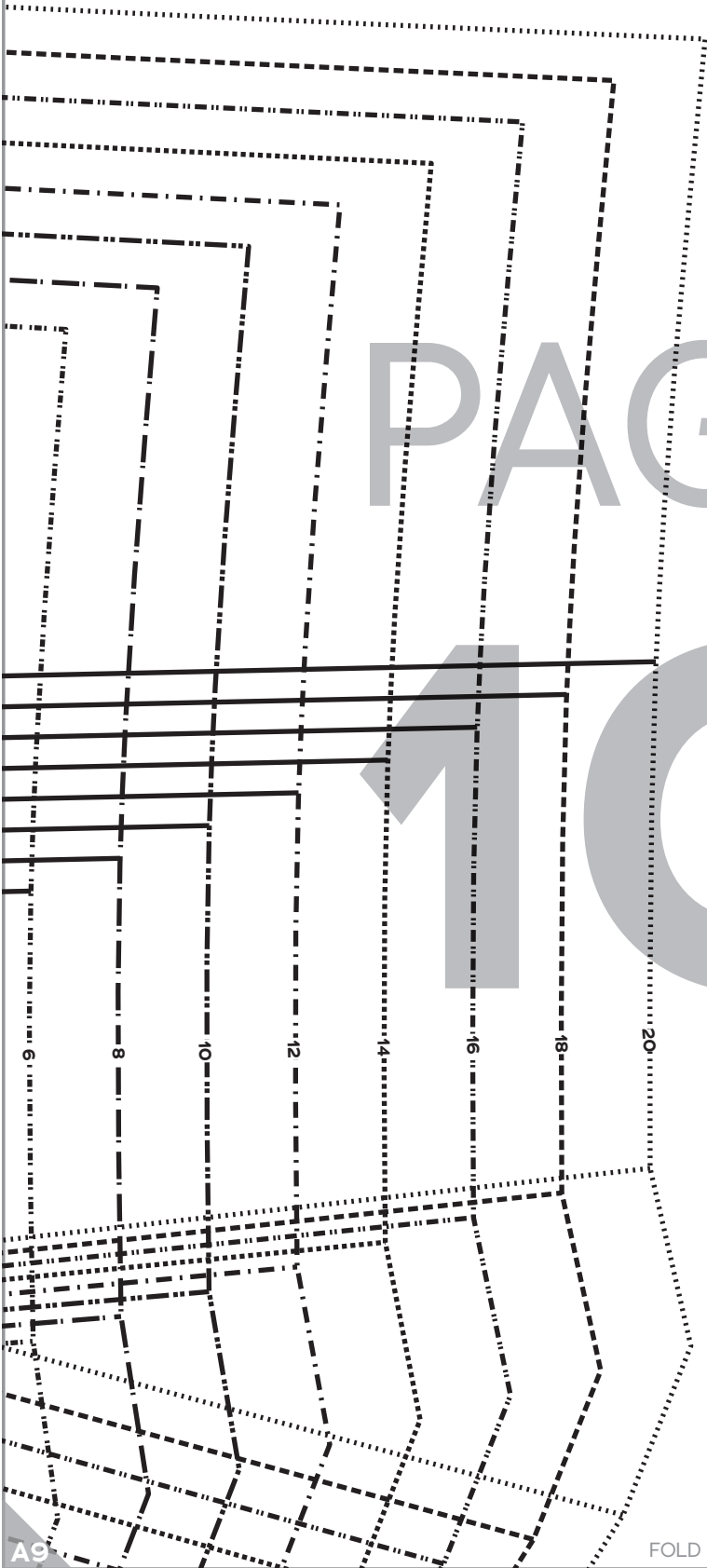

A9

FOLD BACK THIS MARGIN

A10

PAGE

11

13
Pocket
Bag
Cut 4 fabric

GRAINLINE

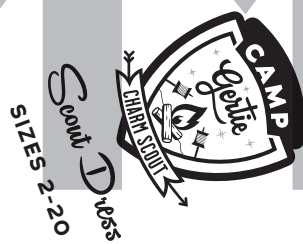

A10

FOLD BACK THIS MARGIN

PAGE

12

SHORTEN/LENGTHEN

FOLD BACK THIS MARGIN

FOLD BACK THIS MARGIN

A1

A2

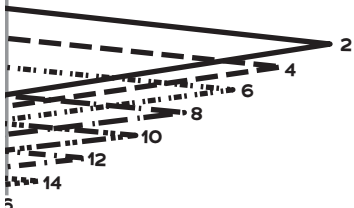

PAGE

FOLD BACK THIS MARGIN

THEN LINE

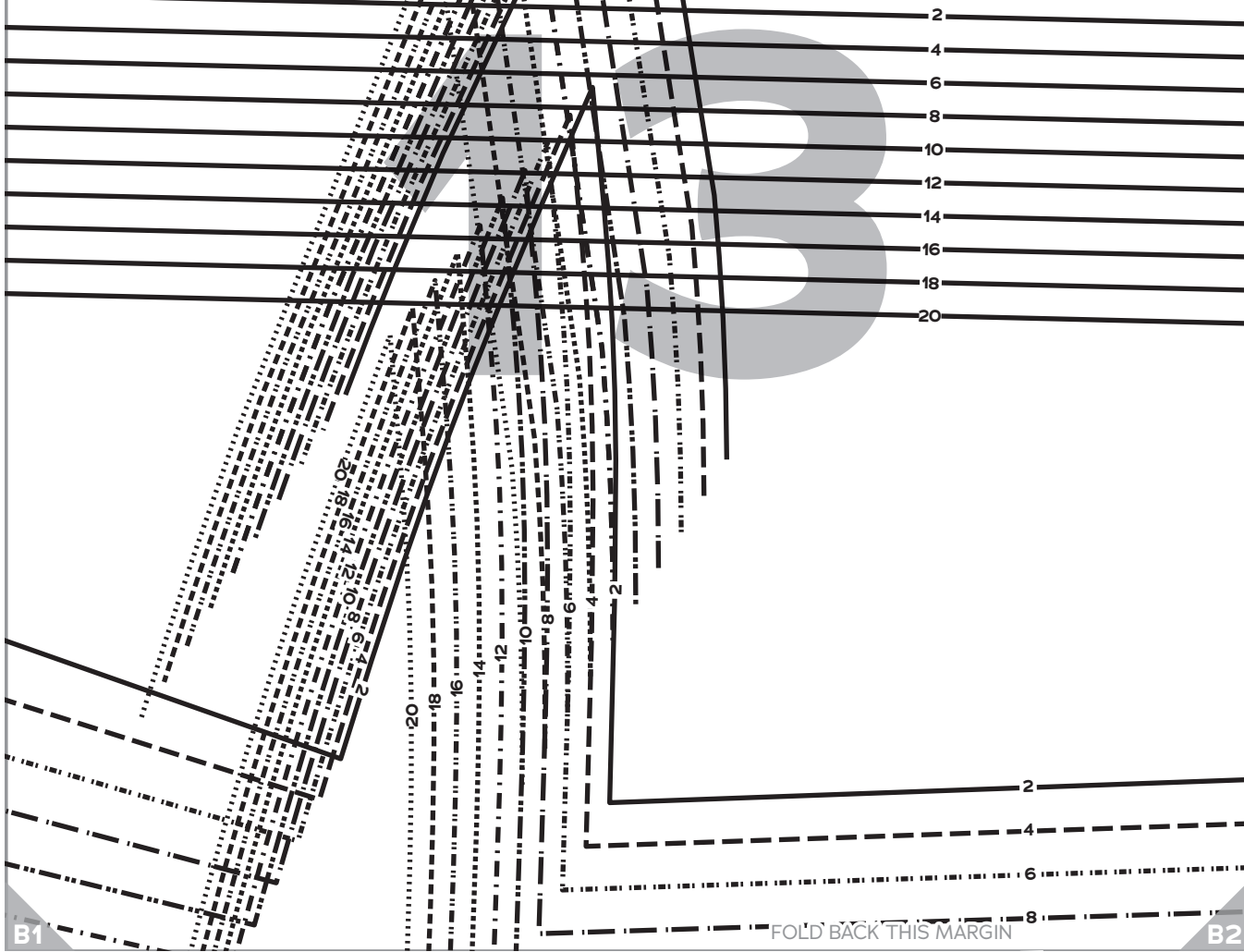

B1

B2

FOLD BACK THIS MARGIN

A2

A3

CENTER FRONT

LAPEL
TURN
OUT
POINT

CENTER FRONT

PAGE

14

Bodice
Front,
B/C Cup
Cut 2 fabric



SIZES 2-20

Scout Dress



FOLD BACK THIS MARGIN

COLLAR
MATCH
POINT

- 2
- 4
- 6
- 8
- 10
- 12
- 14
- 16
- 18
- 20

- 2
- 4
- 6
- 8
- 10
- 12
- 14
- 16
- 18
- 20

- 2
- 4
- 6
- 8
- 10
- 12
- 14
- 16
- 18
- 20

B2

FOLD BACK THIS MARGIN

B3

A3

A4

GRAINLINE

PAGE

15

FOLD BACK THIS MARGIN

FOLD BACK THIS MARGIN

B4

A4

A5

FOLD BACK THIS MARGIN

PAGE

16

B4

FOLD BACK THIS MARGIN

B5

A5

A6

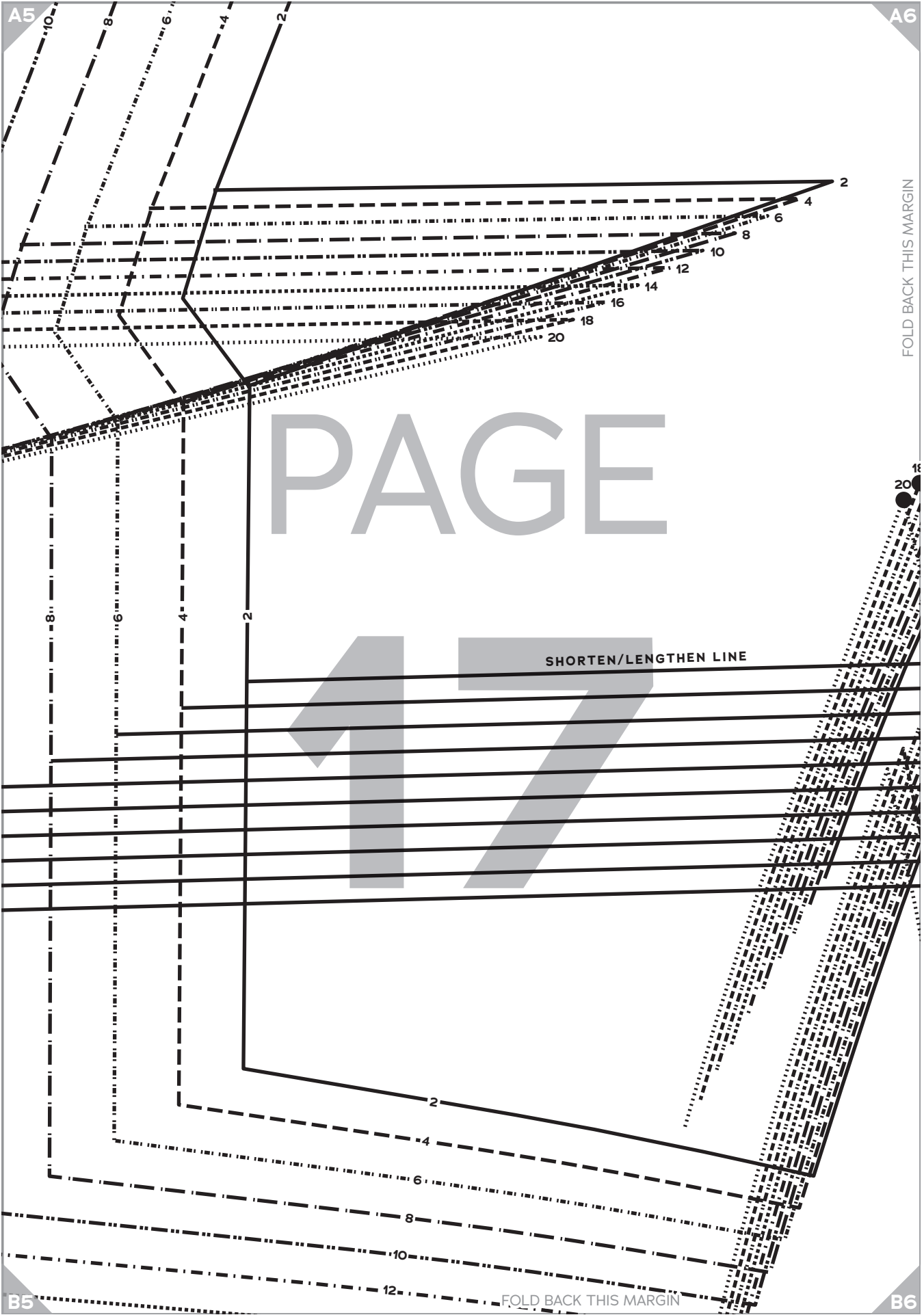

A6

A7

FRONT

●
●
LAPEL
TURNOUT
POINT

PAGE

18

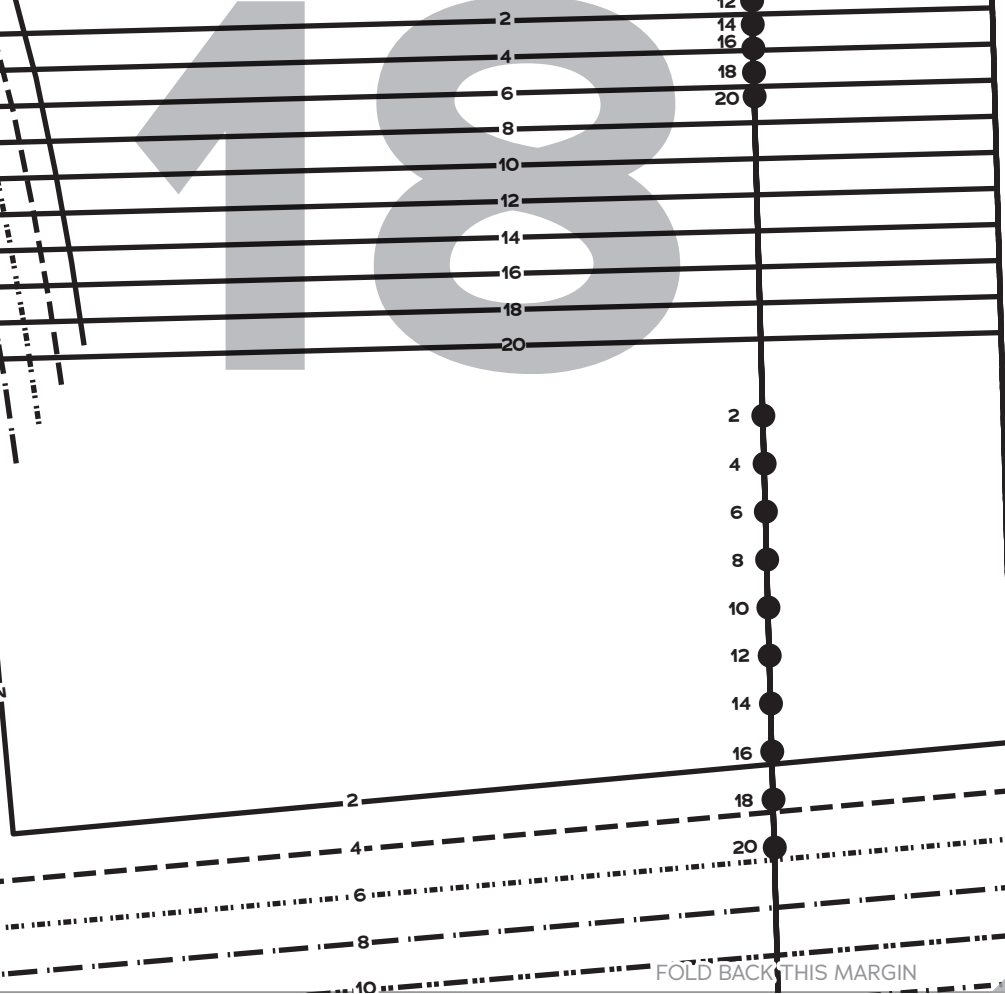

FOLD BACK THIS MARGIN

B6

B7

A7

A8

LAPEL
TURNOUT

CENTER FRONT

Bodice
Front,
F/G Cup
Cut 2 fabric



Scout Dress
SIZES 2-20



PAGE
19

GRAINLINE

COLLAR
MATCH
POINT

FOLD BACK THIS MARGIN

B7

FOLD BACK THIS MARGIN

B8



A8

A9

PAGE

20

FOLD BACK THIS MARGIN

2

4

6

8

10

12

14

16

18

20

2

4

6

8

10

12

14

16

18

20

B8

FOLD BACK THIS MARGIN

B9

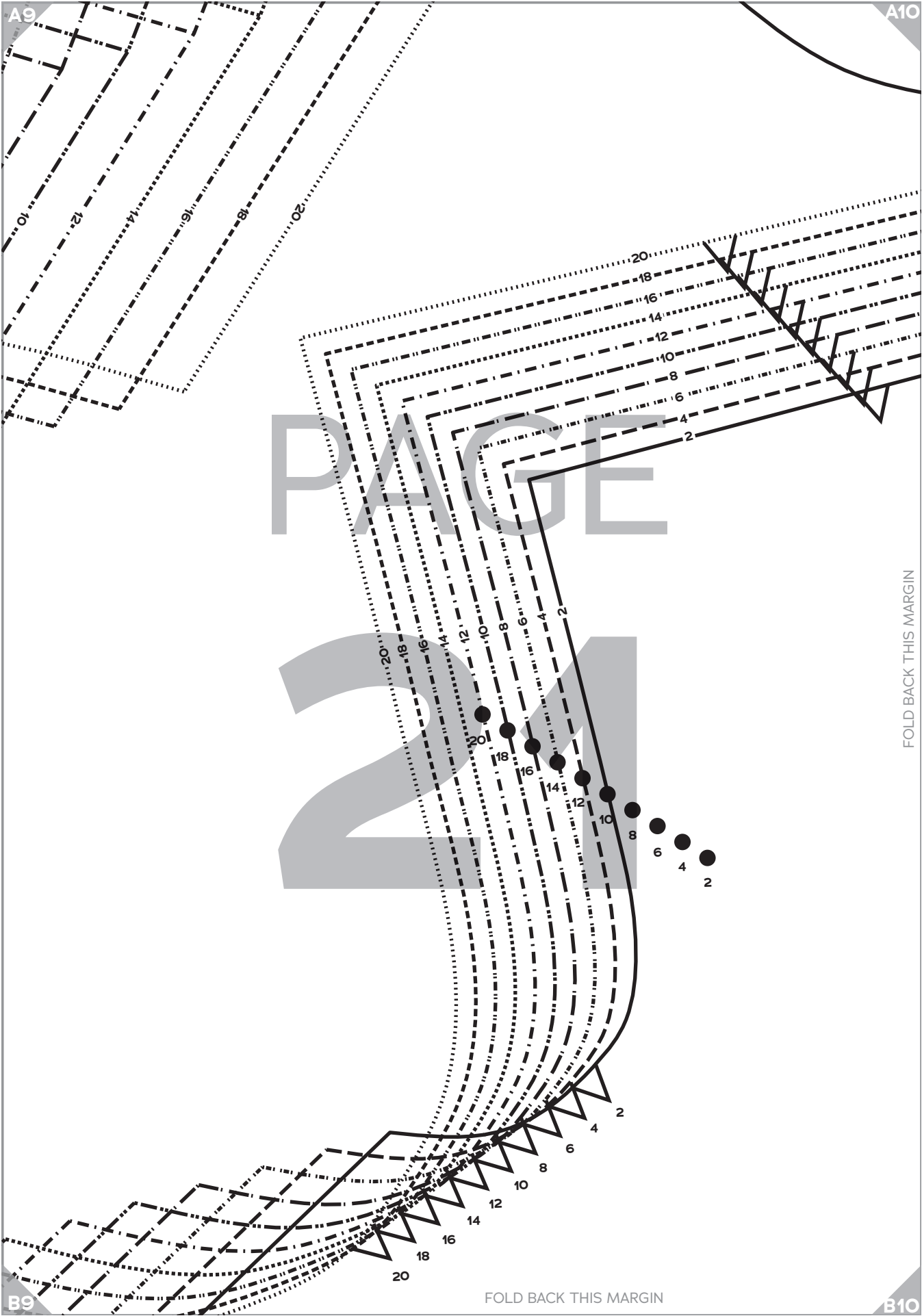

A10

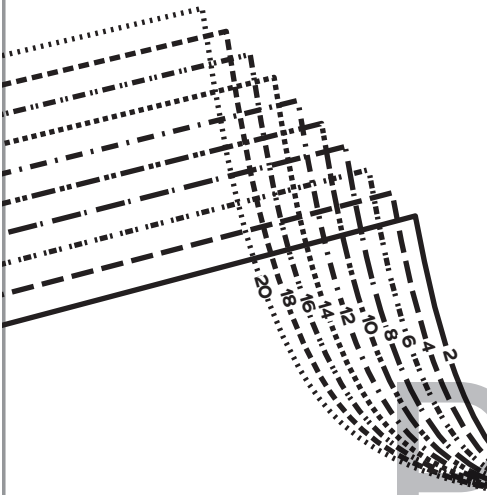

PAGE

22

●
COLLAR
MATCH
POINT



GRAIN



Scout Dress

SIZES 2-20

FOLD BACK THIS MARGIN

B10

B1

16

18

20

SHORTEN/LENGTHEN LINE

PAGE

20

2

4

6

8

10

12

14

16

18

20

FOLD BACK THIS MARGIN

2

4

6

8

10

12

14

16

18

20

FOLD BACK THIS MARGIN

2

4

6

8

10

12

14

16

18

20

C1

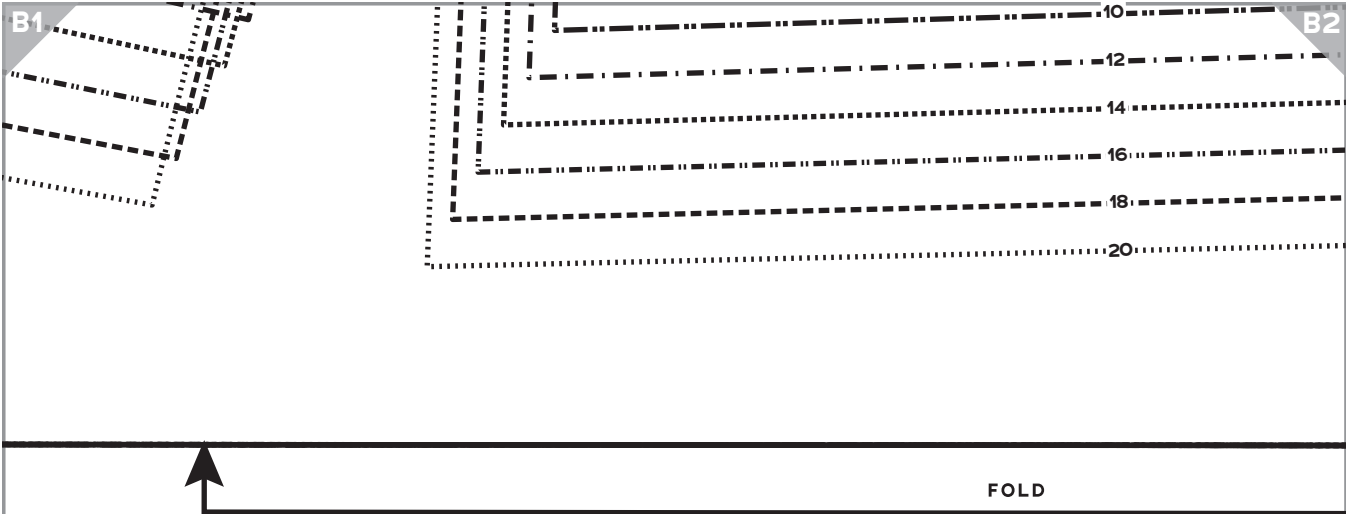

PAGE

24

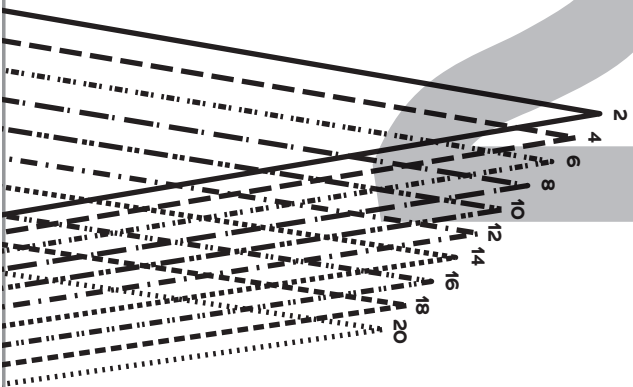

FOLD BACK THIS MARGIN



B2

B3

PAGE

25



Scout Dress

SIZES 2-20

2

Bodice
Back

Cut 1 fabric on fold

FOLD BACK THIS MARGIN

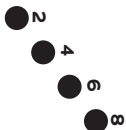

FOLD BACK THIS MARGIN

C2

C3

B3

B4

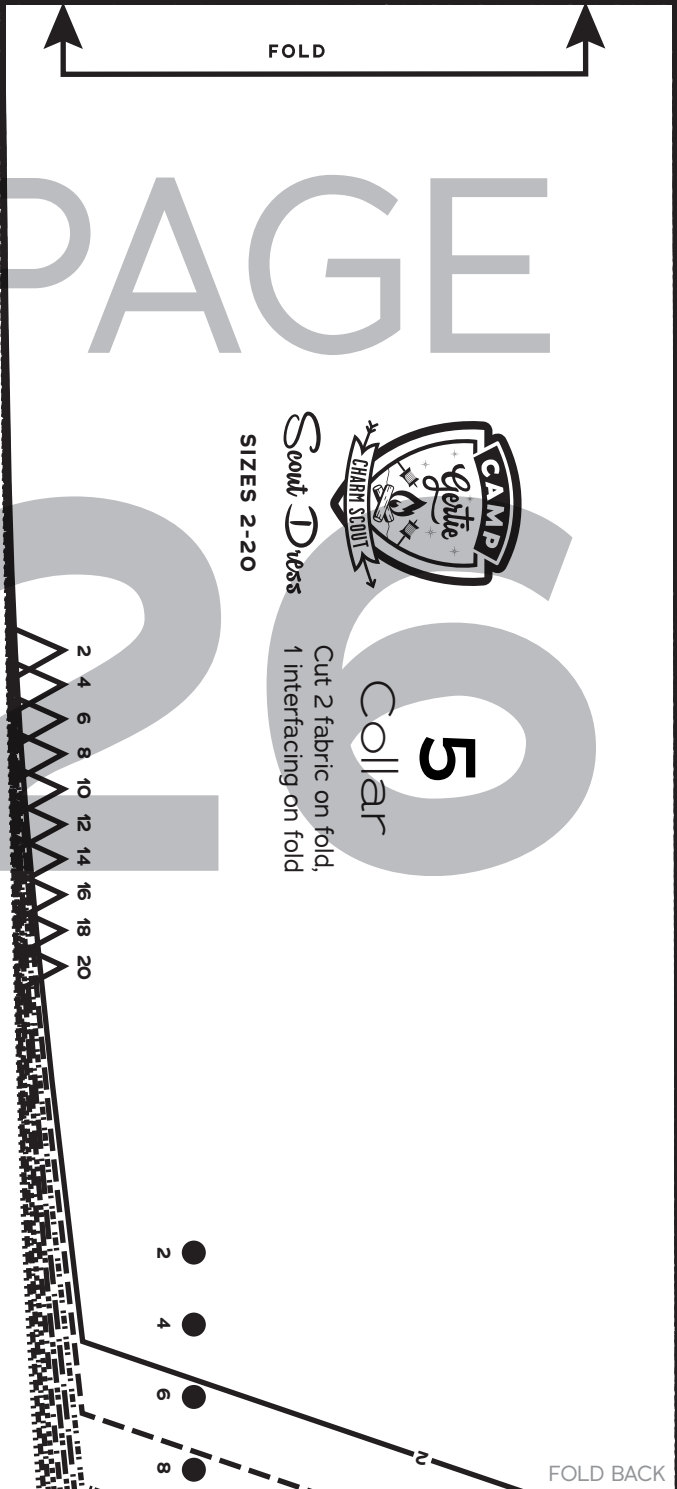
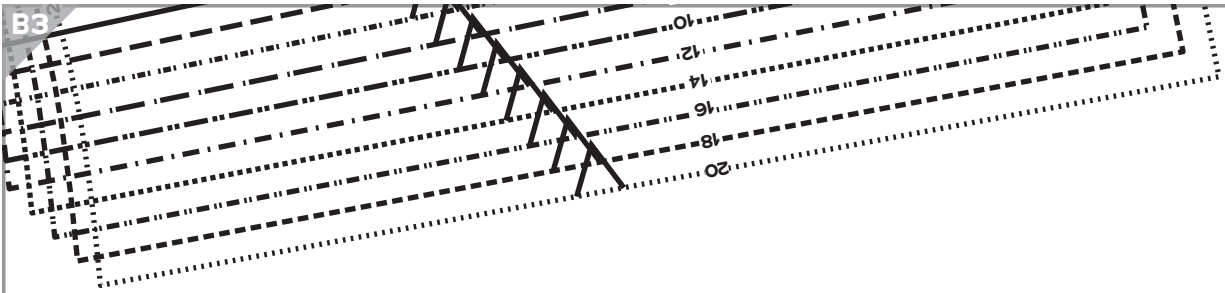

PAGE

26



Scout Dress
SIZES 2-20

Cut 2 fabric on fold,
1 interfacing on fold

5
Collar

2 4 6 8 10 12 14 16 18 20

- 2
- 4
- 6
- 8

C3

C4

FOLD BACK THIS MARGIN

B4

B5

PAGE

27

20"

18"

16"

14"

12"

10"

8"

6"

4"

2"

FOLD BACK THIS MARGIN

C4

FOLD BACK THIS MARGIN

C5

B5

B6

14

16

18

20

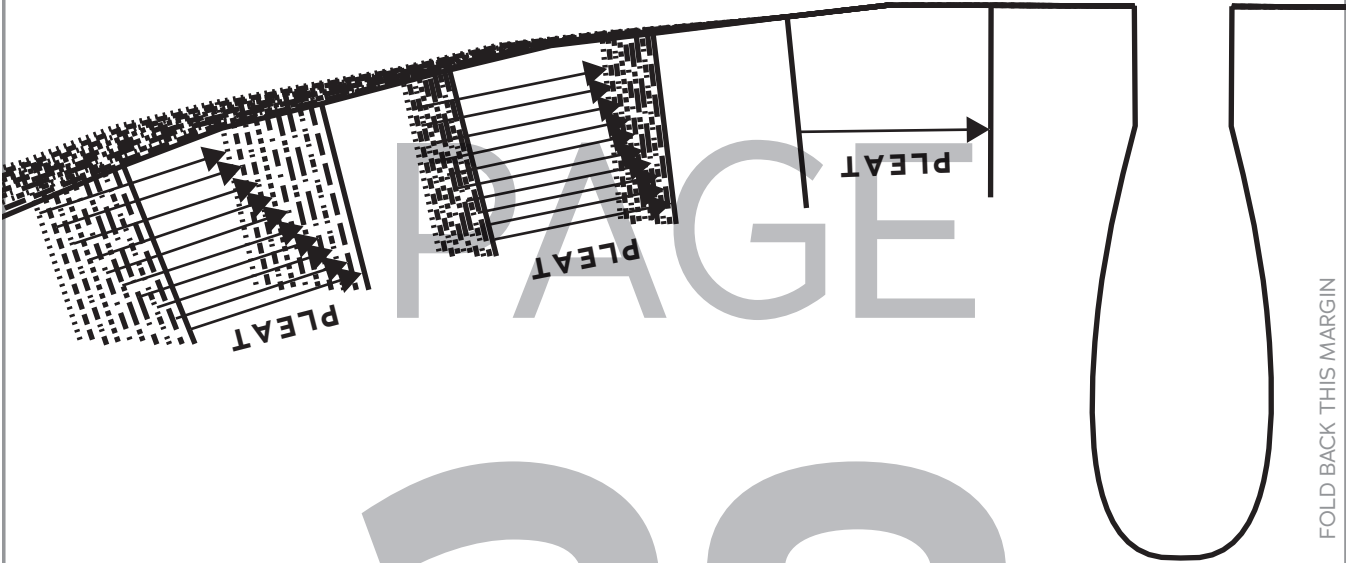

FOLD BACK THIS MARGIN

PAGE 28

Sleeve
Cut 2 fabric

6

Scout Dress
SIZES 2-20



GRAINLINE

C5

C6

FOLD BACK THIS MARGIN

B6

B7

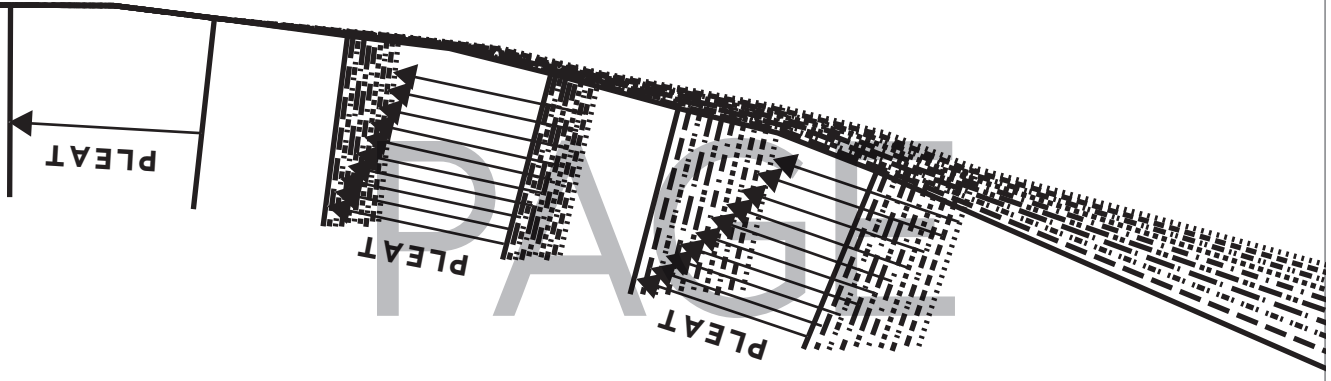
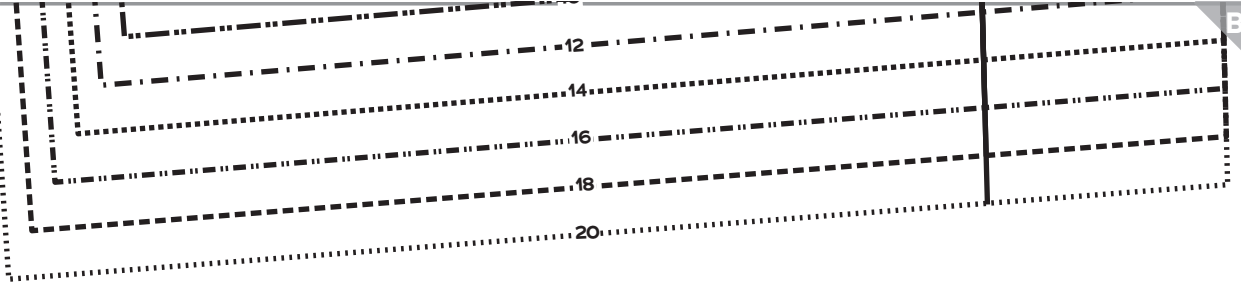

29

FOLD BACK THIS MARGIN

C6

FOLD BACK THIS MARGIN

C7

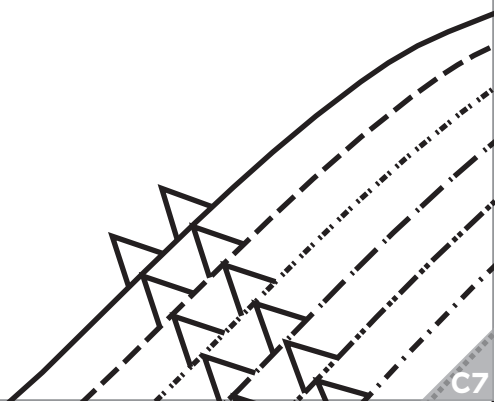

B7

B8

FOLD BACK THIS MARGIN

PAGE

30

2

4

6

8

10

12

14

16

18

20

C7

FOLD BACK THIS MARGIN

C8

B8

B9

PAGE
31

FOLD BACK THIS MARGIN

FOLD BACK THIS MARGIN

C8

C9



B10

LINE

1
Bodice
Front,
H Cup
Cut 2 fabric

CENTER FRONT

●
LAPEL
TURNOUT
POINT

PAGE

33

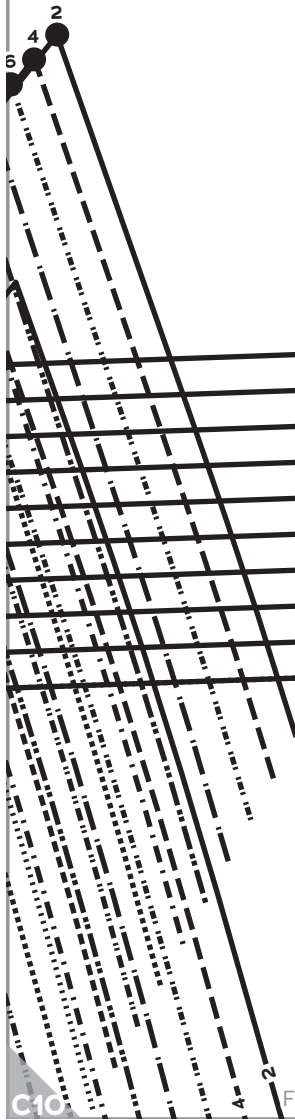

- 2 ●
- 4 ●
- 6 ●
- 8 ●
- 10 ●
- 12 ●
- 14 ●
- 16 ●
- 18 ●
- 20 ●

- 2 ●
- 4 ●
- 6 ●
- 8 ●
- 10 ●
- 12 ●
- 14 ●
- 16 ●
- 18 ●

C10

FOLD BACK THIS MARGIN

C1

FOLD BACK THIS MARGIN

PAGE

34

FOLD BACK THIS MARGIN

D1

C1

C2

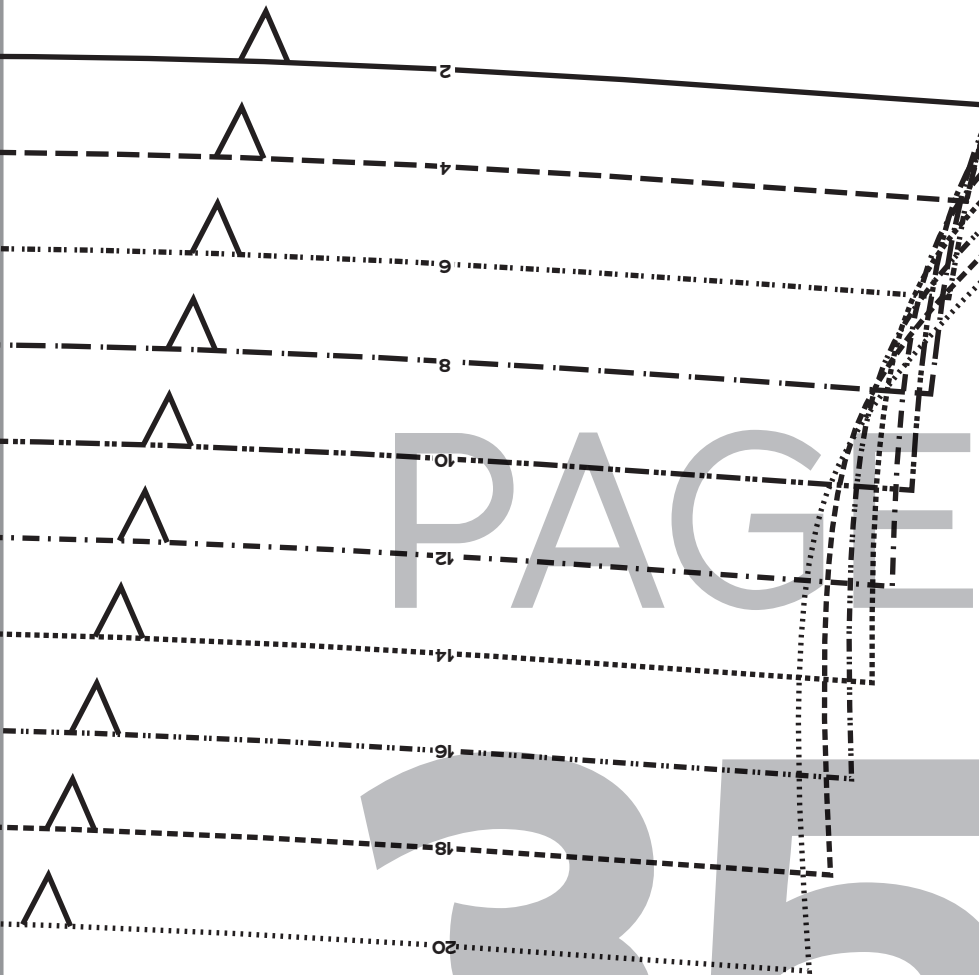

PAGE

35

FOLD BACK THIS MARGIN

D1

FOLD BACK THIS MARGIN

D2



PAGE

36

C2

C3

D2

D3

FOLD BACK THIS MARGIN

FOLD BACK THIS MARGIN

PLEAT

PLEAT

C3

C4

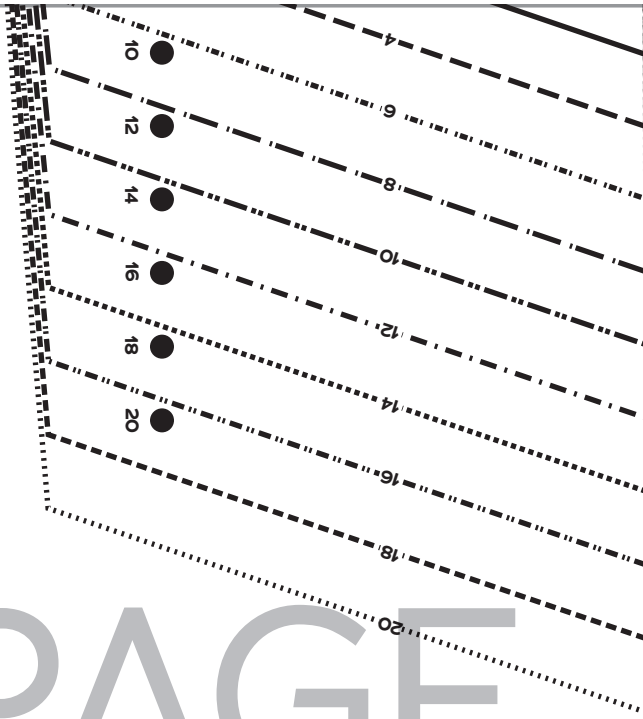

PAGE

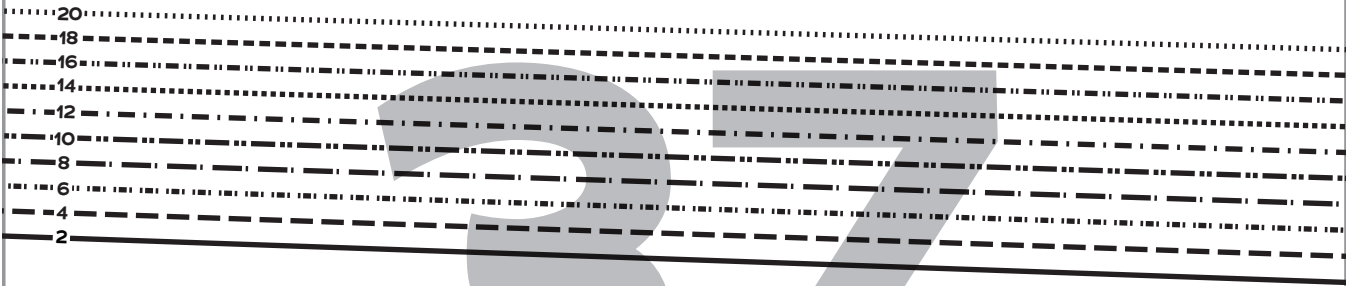

37

FOLD BACK THIS MARGIN

D3

FOLD BACK THIS MARGIN

D4

C4

C5

PAGE

38

FOLD BACK THIS MARGIN

D4

FOLD BACK THIS MARGIN

D5

C5

C6

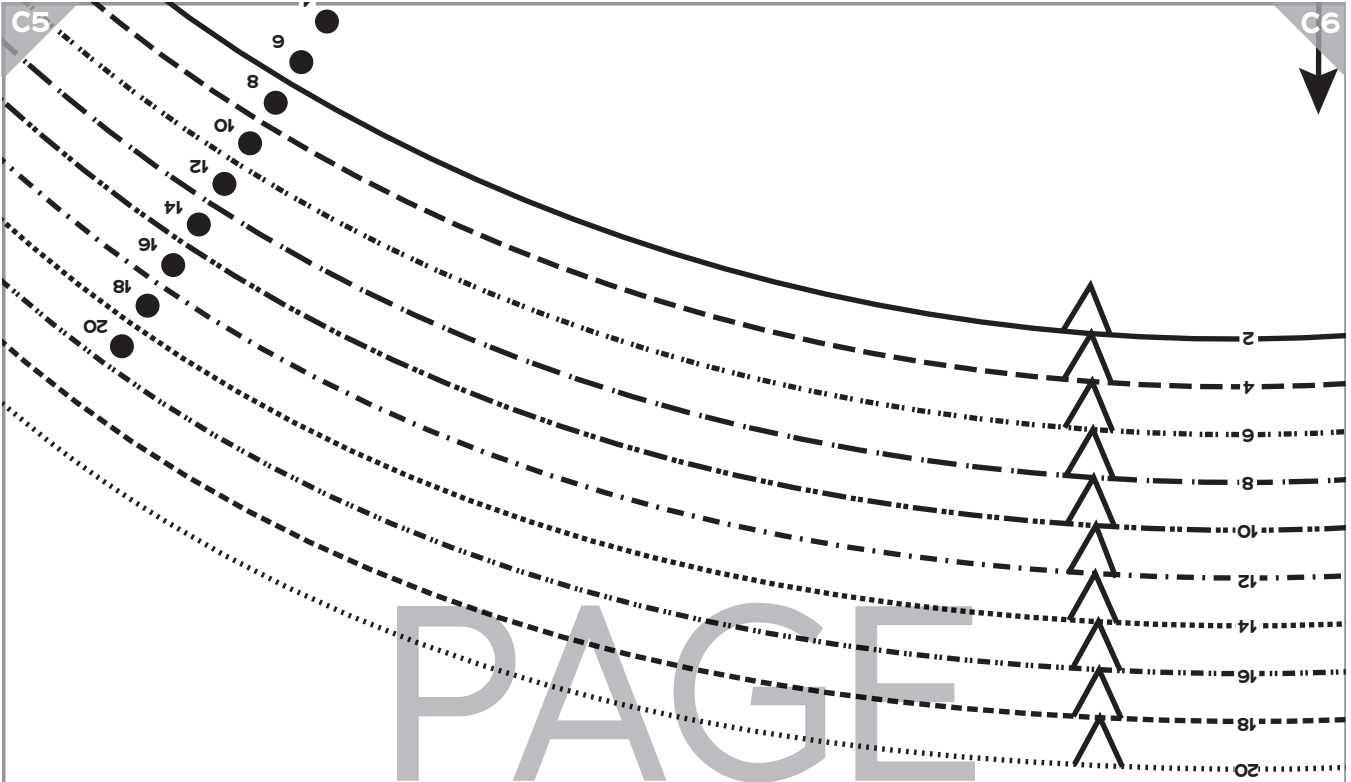

PAGE

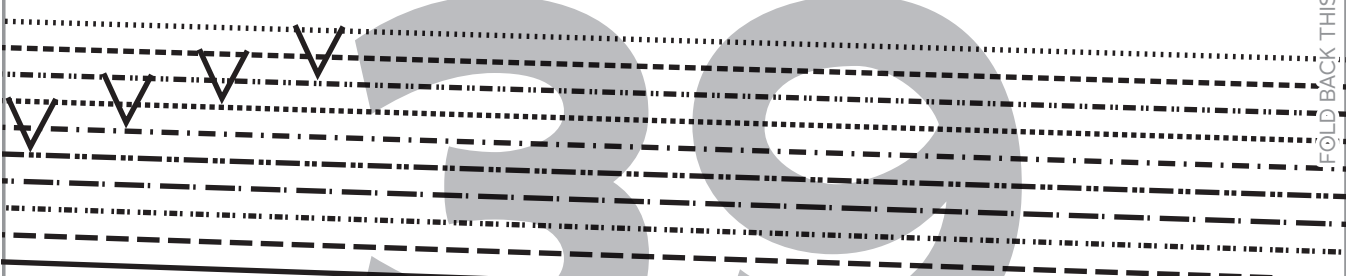

FOLD BACK THIS MARGIN

D5

FOLD BACK THIS MARGIN

D6

C6

C7

- 2
- 4
- 6
- 8
- 10
- 12
- 14
- 16
- 18
- 20

PAGE

40

FOLD BACK THIS MARGIN

D6

FOLD BACK THIS MARGIN

D7

C7

C8

PAGE 41

FOLD BACK THIS MARGIN

Scout Dress
SIZES 2-20



Sleeve Band
Cut 2 fabric,
2 interfacing

GRAINLINE

D7

FOLD BACK THIS MARGIN

D8

C8

C9

PAGE

42

FOLD BACK THIS MARGIN

PLEAT

D8

FOLD BACK THIS MARGIN

D9

C9

C10



PAGE 43

FOLD BACK THIS MARGIN

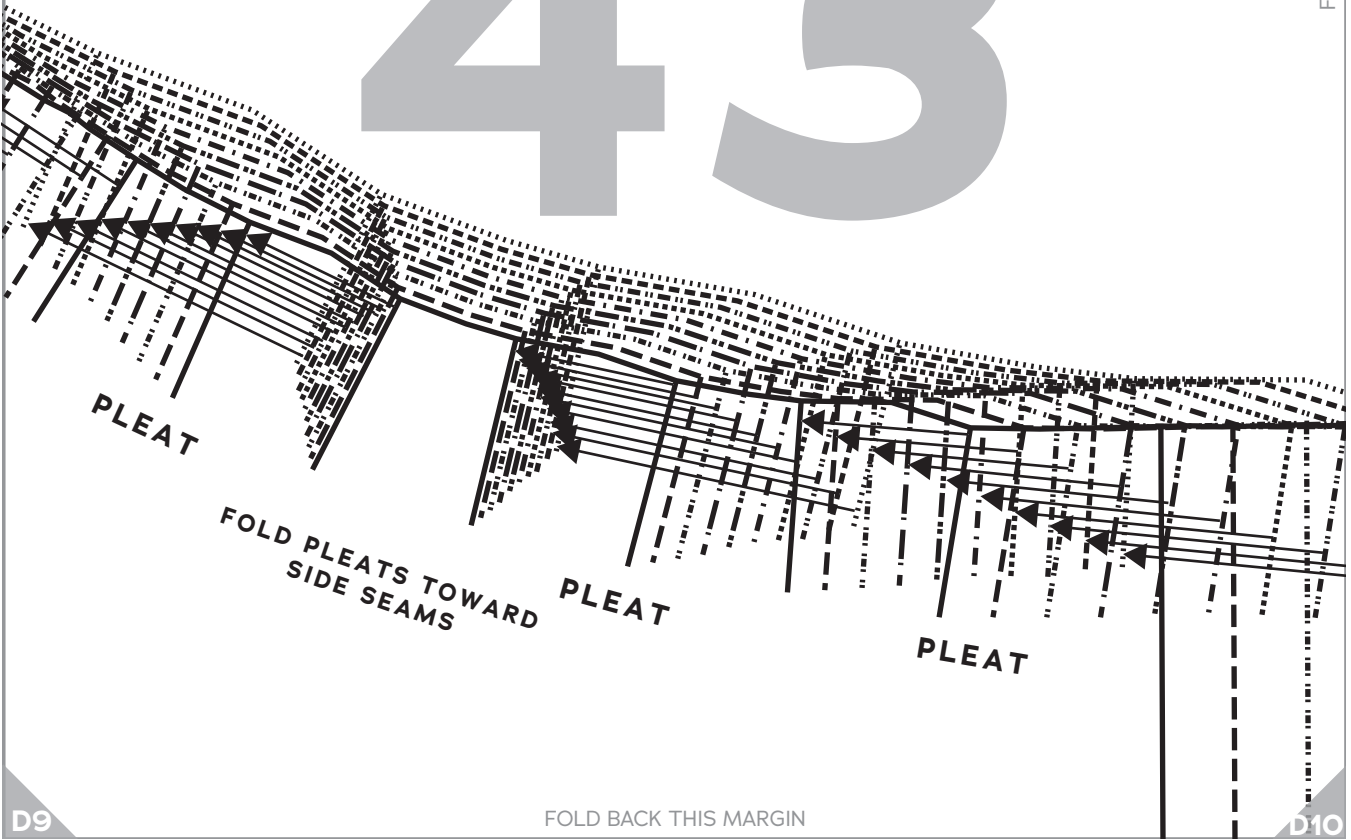

D9

FOLD BACK THIS MARGIN

D10

C10

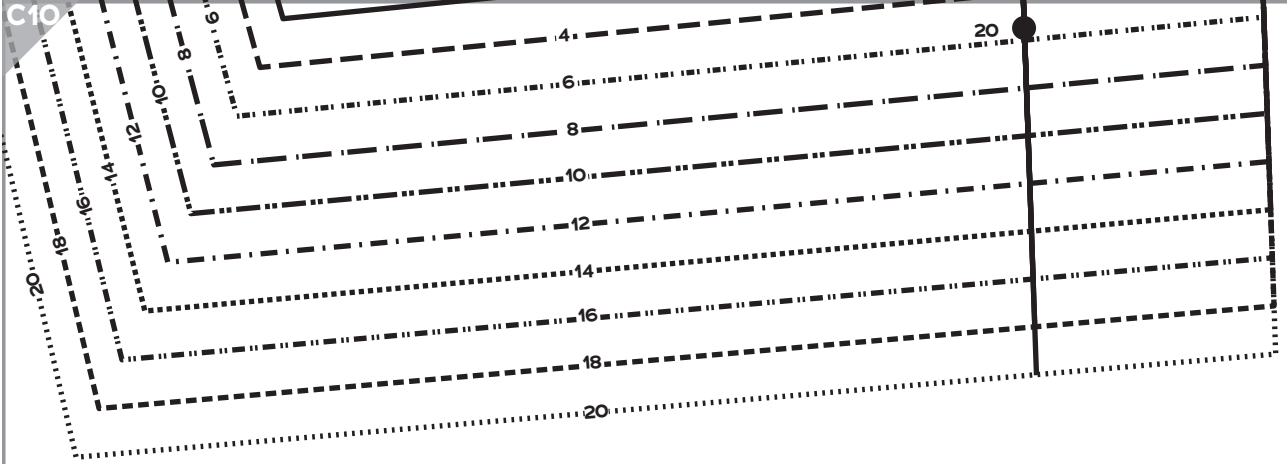

PAGE

44

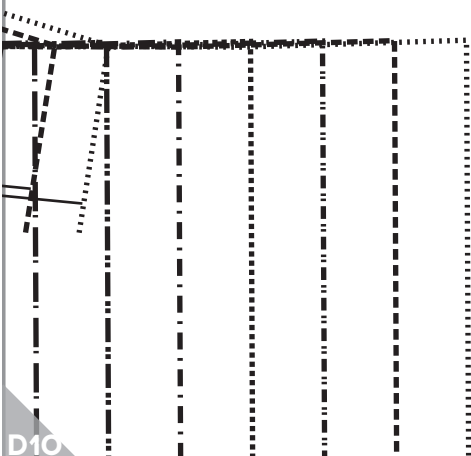

D10

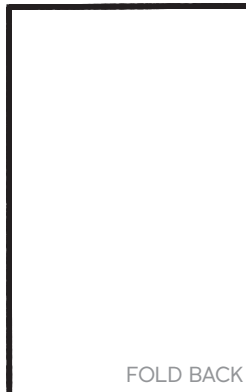

FOLD BACK THIS MARGIN

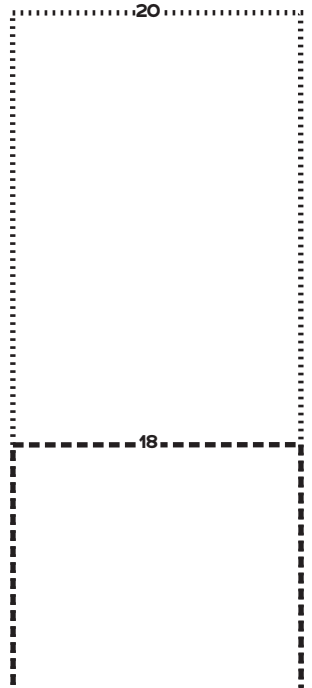

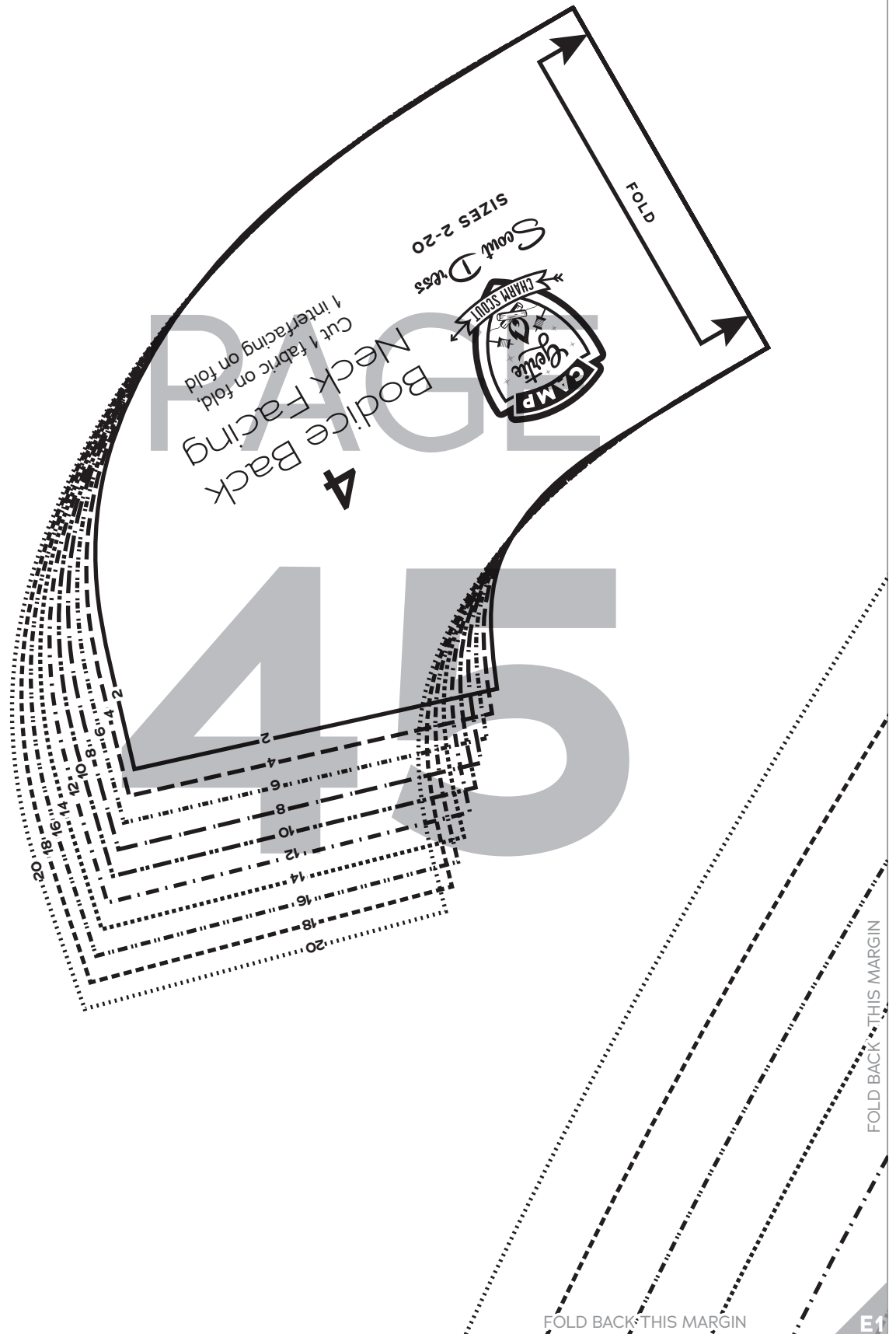

D1

D2

FOLD BACK THIS MARGIN

PLEAT

PAGE

46

E1

FOLD BACK THIS MARGIN

E2

D2

SEAT

D3

PAGE

47

FOLD BACK THIS MARGIN



E2

FOLD BACK THIS MARGIN

E3

D3

D4



Scout Dress
SIZES 2-20

PAGE

12

Skirt
Back

Cut 1 fabric on fold

48

FOLD BACK THIS MARGIN

E3

FOLD BACK THIS MARGIN

E4

D4

D5

PAGE

49

FOLD BACK THIS MARGIN

E4

FOLD BACK THIS MARGIN

E5

D5

D6

PAGE 50

FOLD BACK THIS MARGIN

E5

FOLD BACK THIS MARGIN

E6

D6

D7

PAGE 54

FOLD BACK THIS MARGIN

E6

FOLD BACK THIS MARGIN

E7

D7

D8

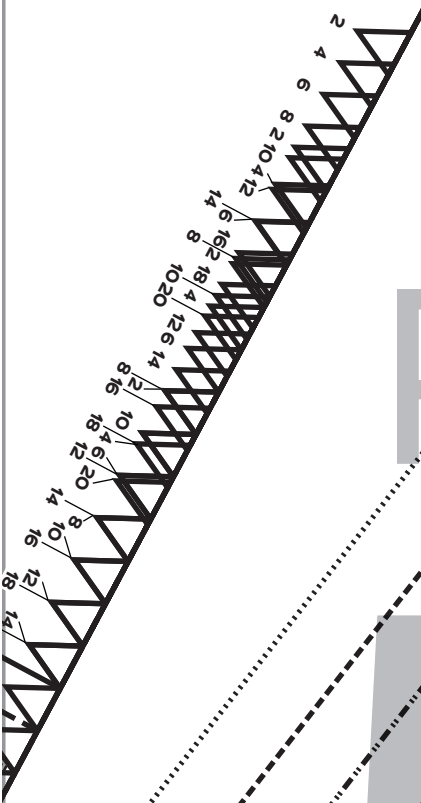

PAGE
52

FOLD BACK THIS MARGIN

E7

FOLD BACK THIS MARGIN

E8

D8

D9

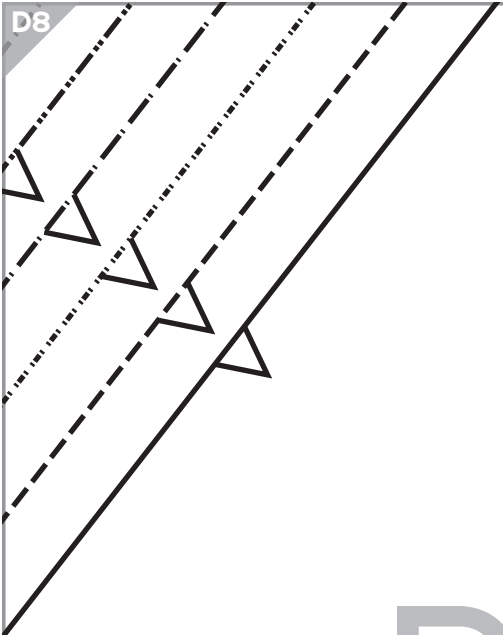

PAGE

53

Scout
SIZES

11

Skirt Side
Front/Back
Cut 4 fabric

FOLD BACK THIS MARGIN

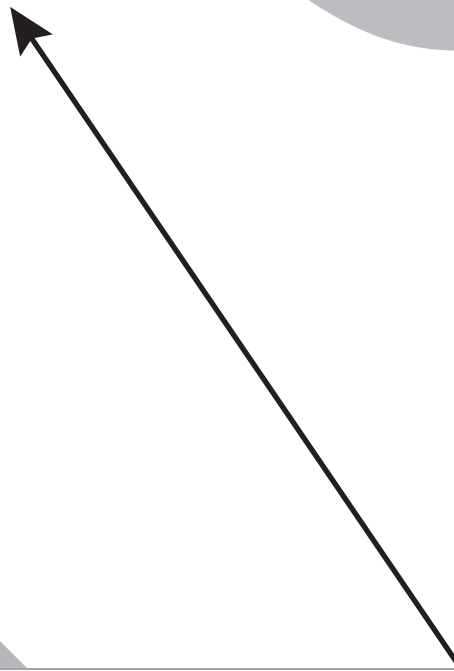

E8

FOLD BACK THIS MARGIN

E9

D9

D10



Scout Dress
2-20

de
ck

PAGE

54



FOLD BACK THIS MARGIN

2

4

6

E9

FOLD BACK THIS MARGIN

E10

D10

E10

PAGE 55

GRAINLINE

FOLD BACK THIS MARGIN

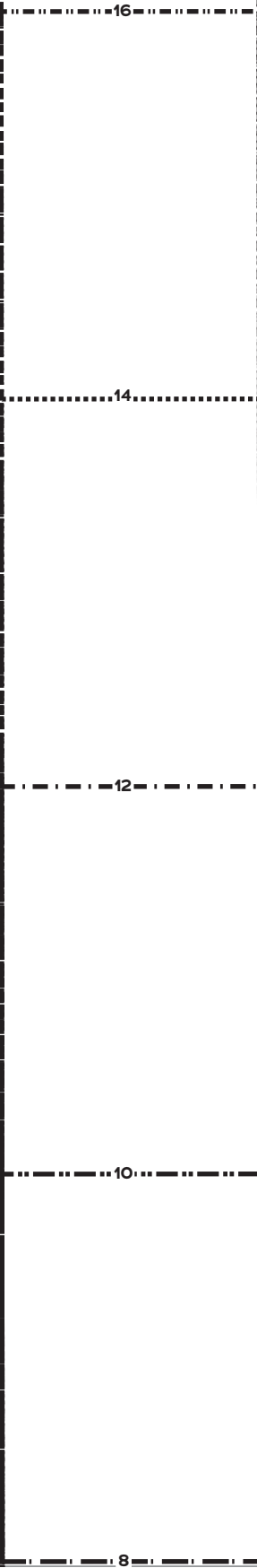

E1

PAGE

56

20

18

16

14

12

10

8

6

4

2

FOLD BACK THIS MARGIN

FOLD BACK THIS MARGIN

F1

E1

E2

PAGE

57

FOLD BACK THIS MARGIN

F1

FOLD BACK THIS MARGIN

F2

E2

E3

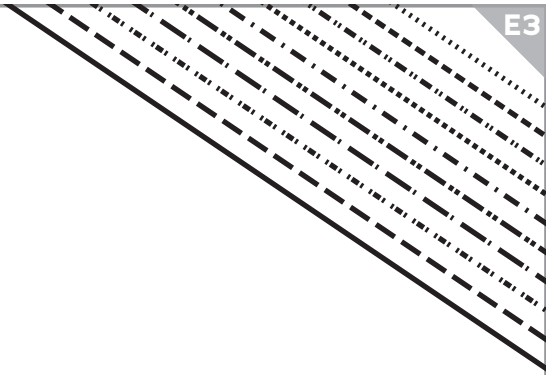

PAGE

58

FOLD BACK THIS MARGIN

F2

FOLD BACK THIS MARGIN

F3

E3

E4

FOLD



PAGE

59

20
18
16
14
12
10
8
6
4
2

FOLD BACK THIS MARGIN

F3

FOLD BACK THIS MARGIN

F4

E4

E5

PAGE

60

FOLD BACK THIS MARGIN



F4

FOLD BACK THIS MARGIN

F5

E5

E6

PAGE

61

FOLD BACK THIS MARGIN

F5

FOLD BACK THIS MARGIN

F6

E6

E7

18

20

PAGE

62

FOLD BACK THIS MARGIN

F6

FOLD BACK THIS MARGIN

F7

E7

E8

PAGE

63

FOLD BACK THIS MARGIN

F7

FOLD BACK THIS MARGIN

F8

E8

E9

GRAINLINE

PAGE

64

FOLD BACK THIS MARGIN

F8

FOLD BACK THIS MARGIN

F9

E9

E10

PAGE

65

FOLD BACK THIS MARGIN

F9

FOLD BACK THIS MARGIN

F10

E10

PAGE

66



Skirt Front Interfacing

14

Cut 2 interfacing

6

4

2

FOLD BACK THIS MARGIN

GRA

F10

PAGE
67

FOLD BACK THIS MARGIN



PAGE

68

FOLD BACK THIS MARGIN

- 18
- 16
- 14
- 12
- 10
- 8
- 6
- 4
- 2
- 20
- 18
- 16
- 14
- 12
- 10

GRAINLINE



SIZES 2-20

10

Skirt
Front
Cut 2 fabric

PAGE

69

FOLD BACK THIS MARGIN



CENTER FRONT/FOLD LINE



PAGE 70

FOLD BACK THIS MARGIN

20 18 16 14 12 10 8 6 4 2

2 4 6 8 10 12 14 16 18 20

F4

F5

PAGE 71

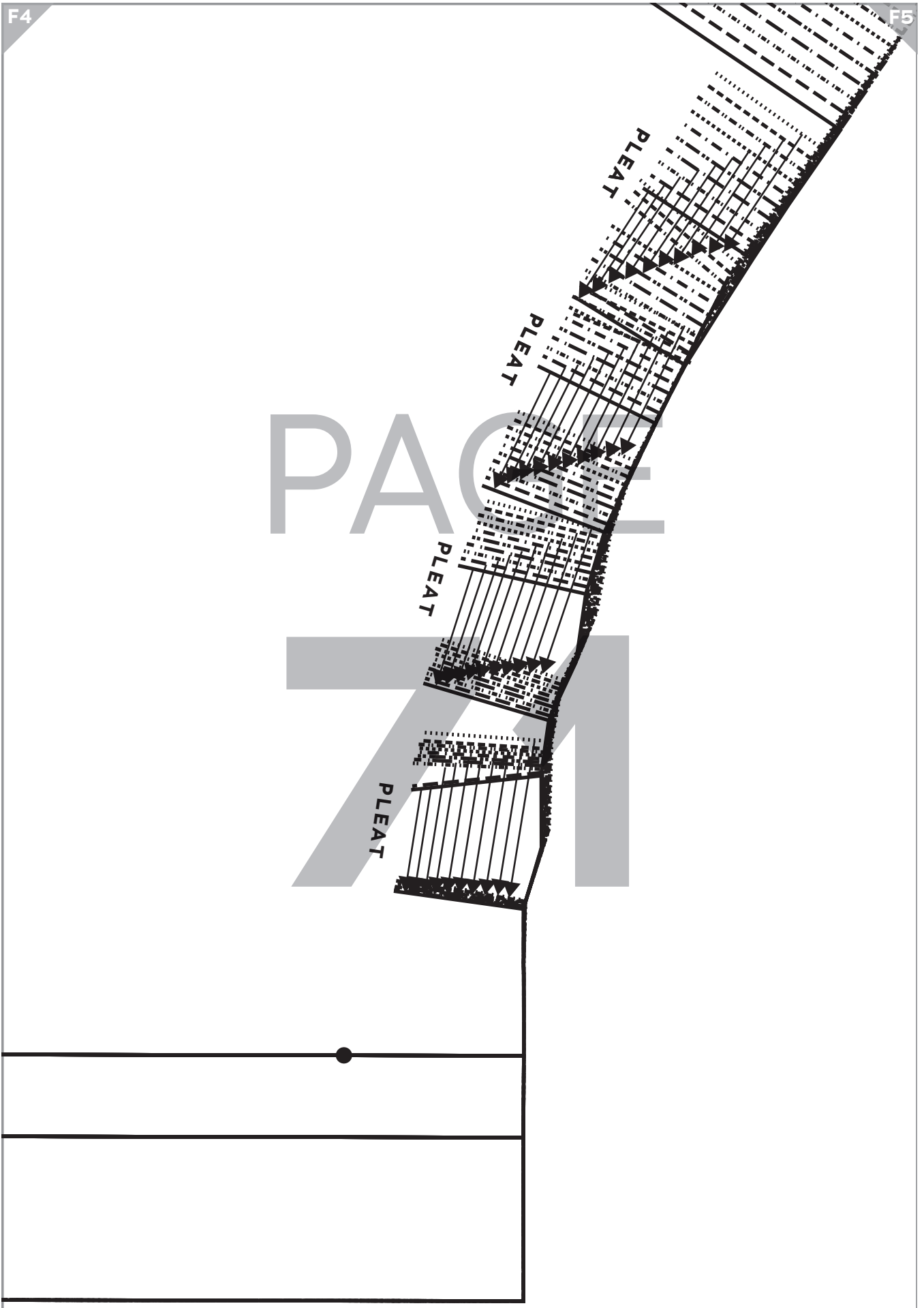

PAGE

72

● COLLAR MATCH POINT

FOLD BACK THIS MARGIN

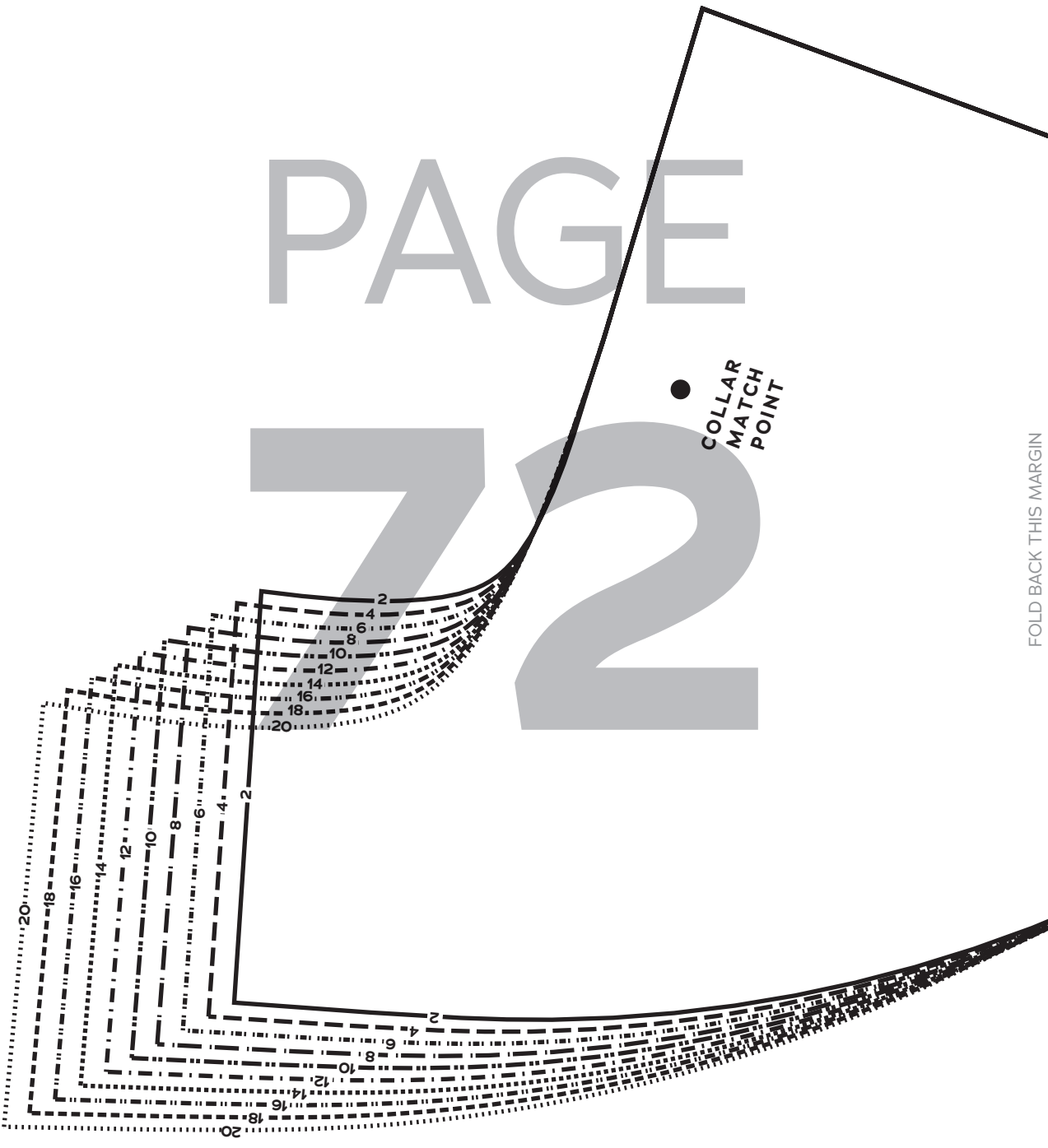

PAGE

73

3

Bodice
Front
Facing,
All Cups
cut 2 fabric,
2 interfacing



Scout **D**resses
SIZES 2-20

●
LAPEL
TURNOUT
POINT

GRAINLINE

FOLD BACK THIS MARGIN

FOLD BACK THIS MARGIN

PAGE

74

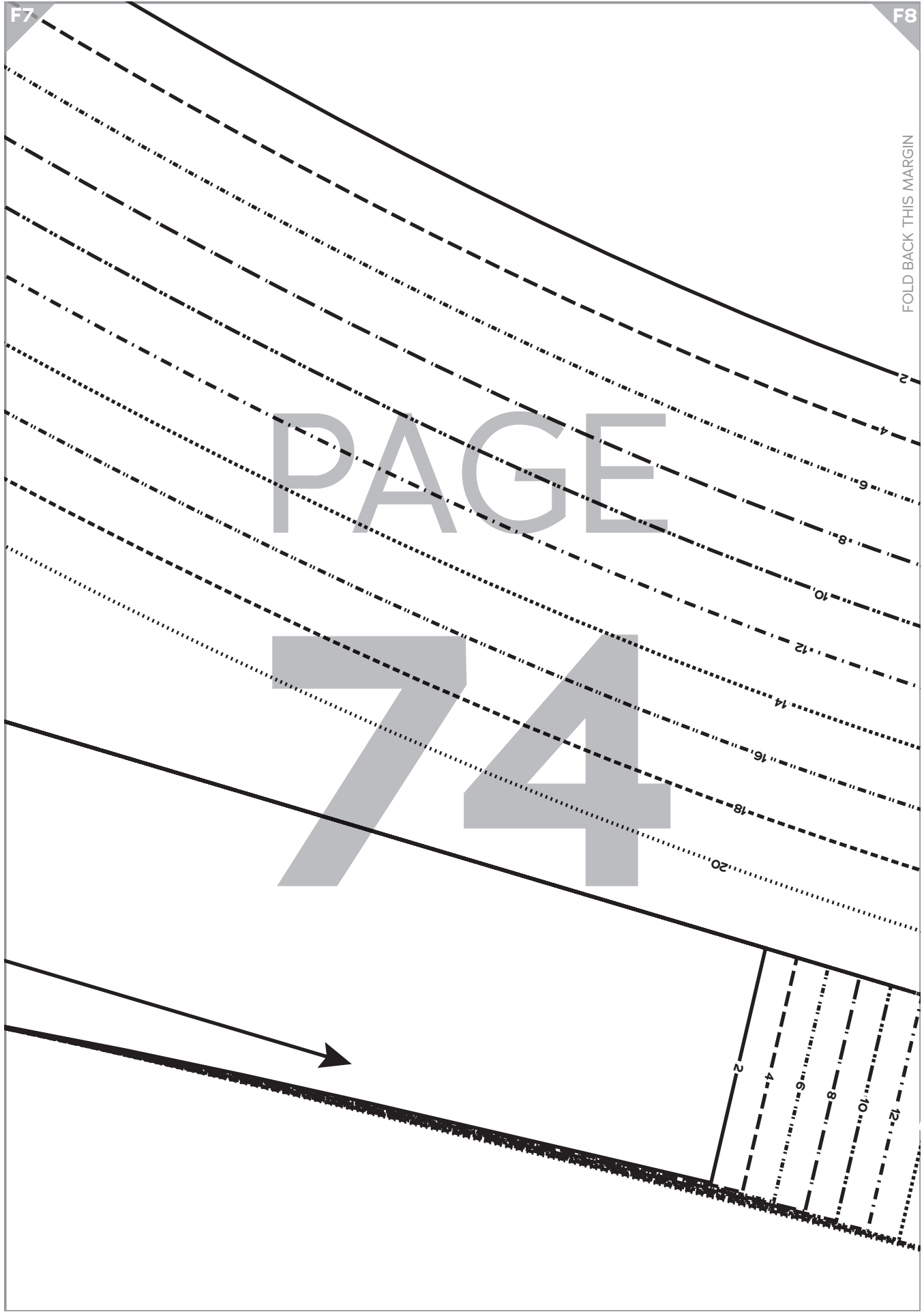

PAGE

75

FOLD BACK THIS MARGIN

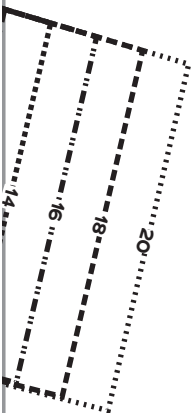

F9

F10

PAGE

76

FOLD BACK THIS MARGIN

F10

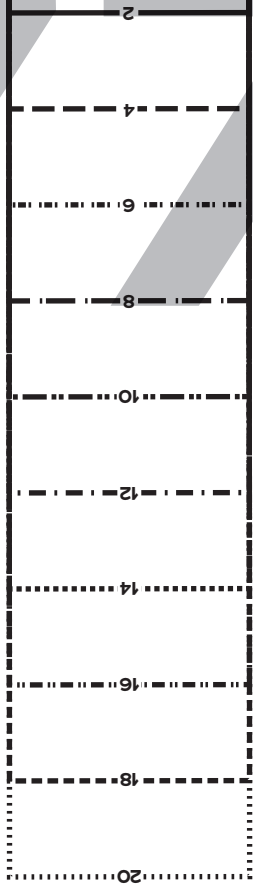
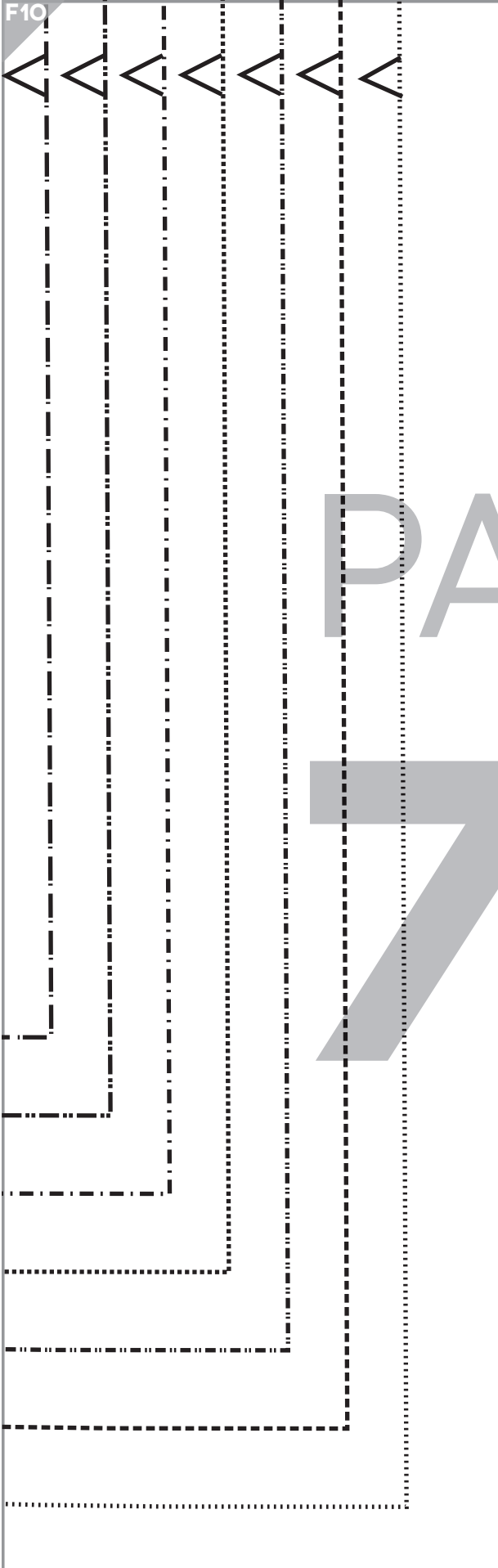

9
Sleeveless Bias Facing
Cut 2 fabric