

Starlet

GOWN

Sizes 18-34
with cup sizes A-H

5/8 inch (in) (1.5 cm) seam allowances are included on all pattern pieces.



SIZE 18-34
PATTERN
SIZE KEY

18	-----
20
22
24	-----
26
28	-----
30	-----
32
34	-----

SYMBOL KEY

grainline arrow



match point/
placement mark



⊕ bust apex

© 2023 Charm Patterns
by Gertie. Distribution
and Commercial Use
Prohibited.

PAGE

1 in
test
square

2 cm
test
square

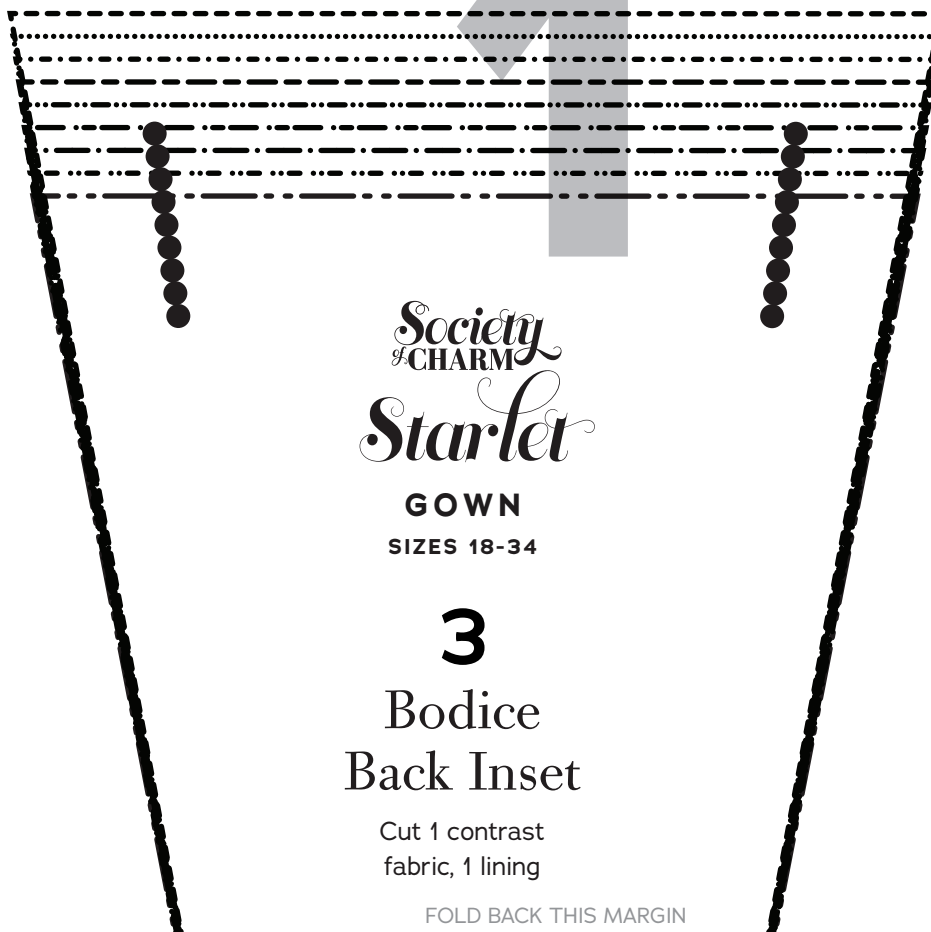

Society of Charm
Starlet
GOWN
SIZES 18-34

3
Bodice
Back Inset

Cut 1 contrast
fabric, 1 lining

FOLD BACK THIS MARGIN

FOLD BACK THIS MARGIN

A1

PAGE

2

FOLD BACK THIS MARGIN

A1

FOLD BACK THIS MARGIN

A2

PAGE

3

FOLD BACK THIS MARGIN

A2

FOLD BACK THIS MARGIN

A3



SHORT SKIRT CUTTING LINE

PAGE

4

FOLD BACK THIS MARGIN

A3

FOLD BACK THIS MARGIN

A4

FOLD

PAGE 5

Skirt Back
Cut 1 fabric on fold

6

GOWN
SIZES 18-34

Society of CHARM
Starlet

FOLD BACK THIS MARGIN

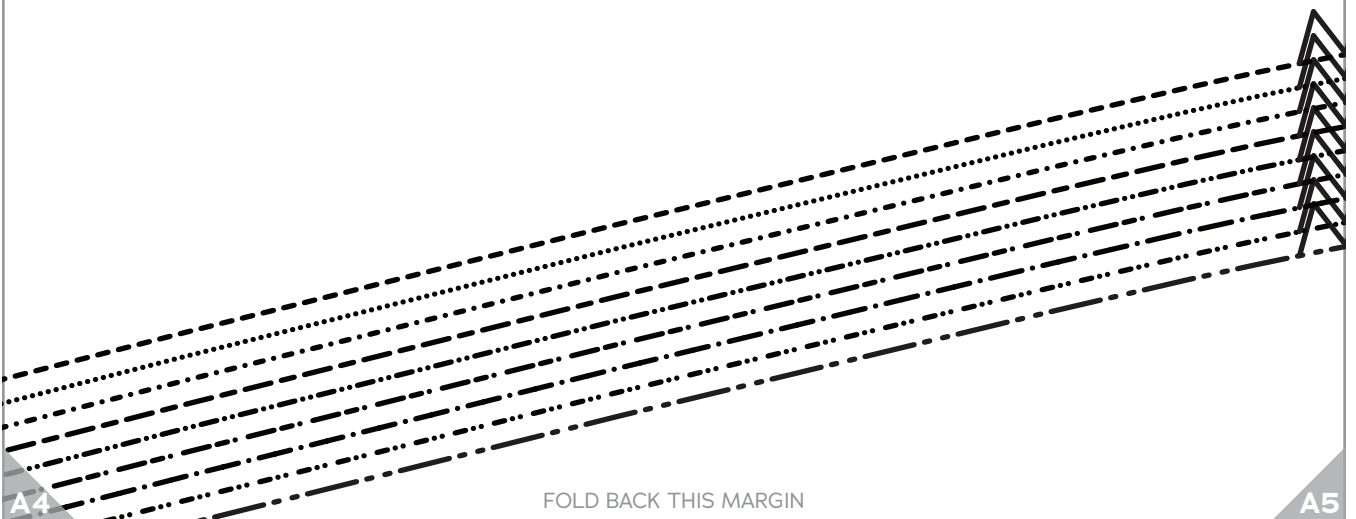

A4

FOLD BACK THIS MARGIN

A5

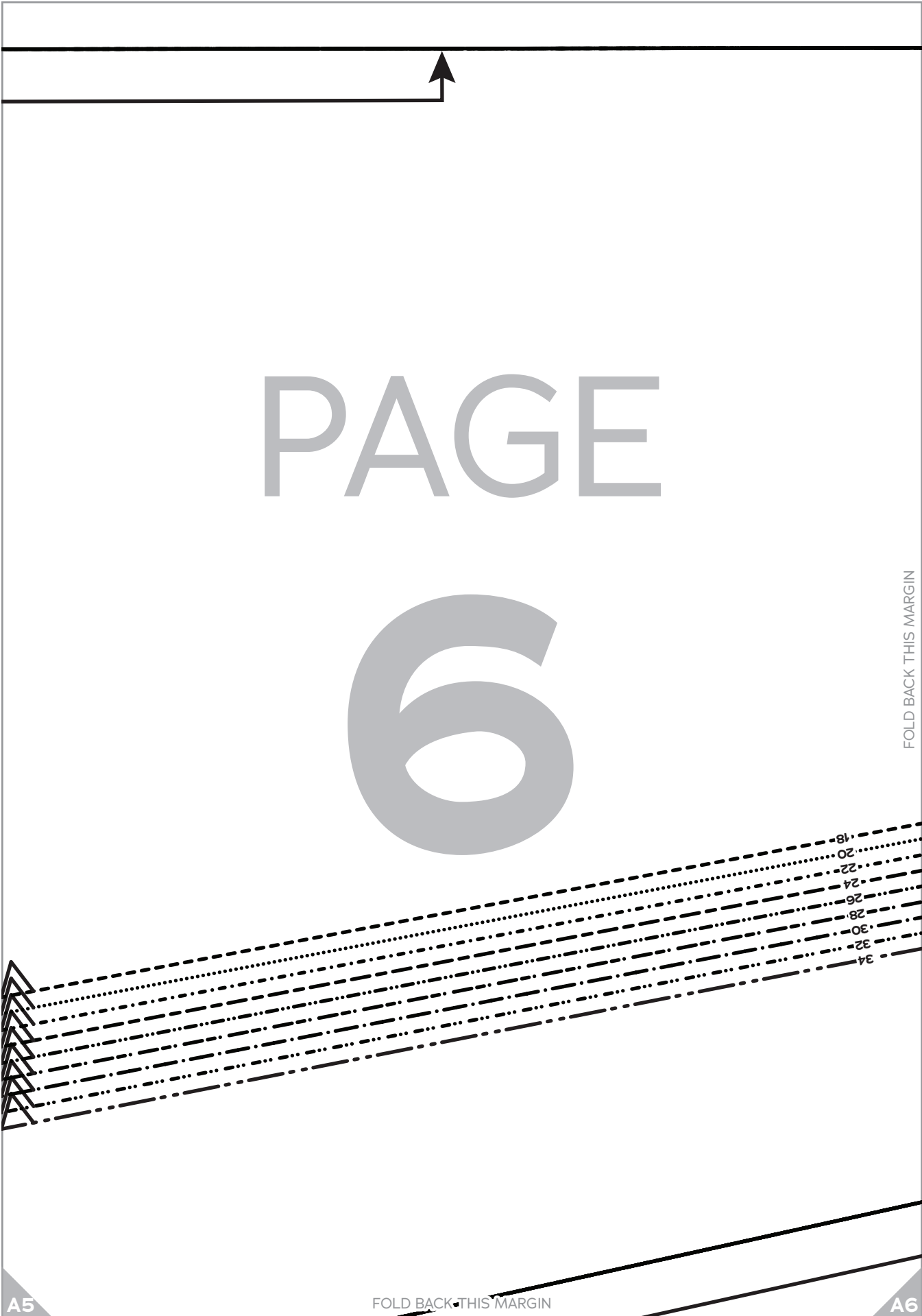

PAGE

6

FOLD BACK THIS MARGIN

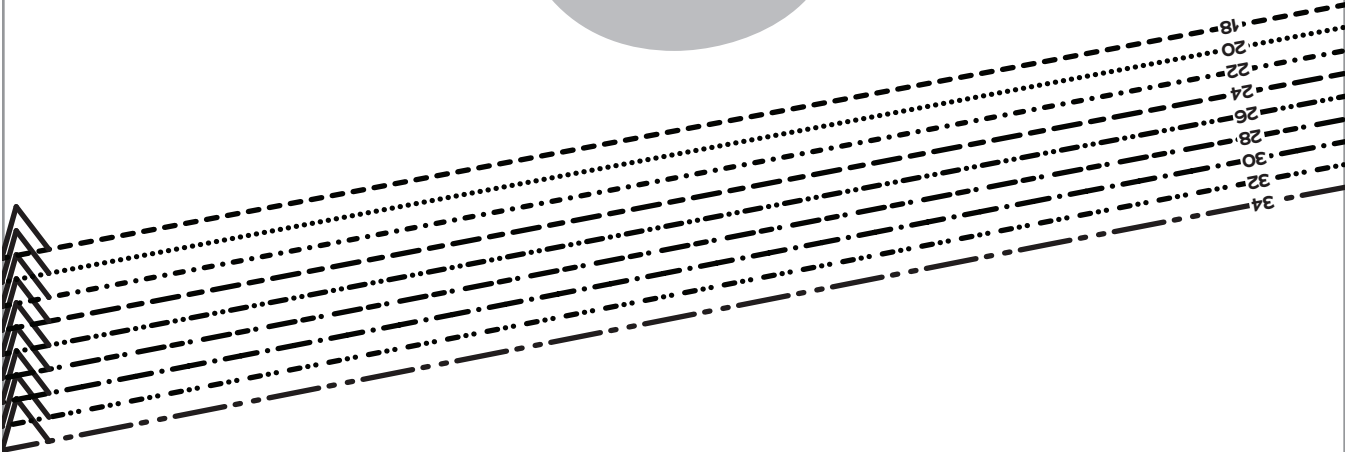

A5

FOLD BACK THIS MARGIN

A6

PAGE

7

LENGTH ADJUSTMENT LINE

FOLD BACK THIS MARGIN

CUTTING LINE

FOLD BACK THIS MARGIN

A6

A7

PAGE

8

FOLD BACK THIS MARGIN

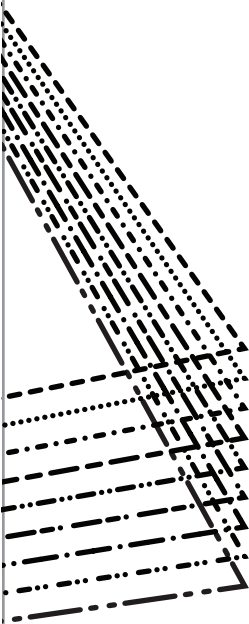

A7

FOLD BACK THIS MARGIN

A8

PAGE

9

FOLD BACK THIS MARGIN

A8

FOLD BACK THIS MARGIN

A9

PAGE

10

LENGTH ADJUSTMENT LINE

FOLD BACK THIS MARGIN



FOLD BACK THIS MARGIN

A9

A10

PAGE

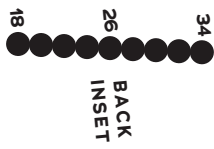

FOLD BACK THIS MARGIN

GRAINLINE



2
 Bodice
 Back
 Cut 2 fabric, 2 lining

GOWN
SIZES 18-34

*Society
of CHARM*
Starlet

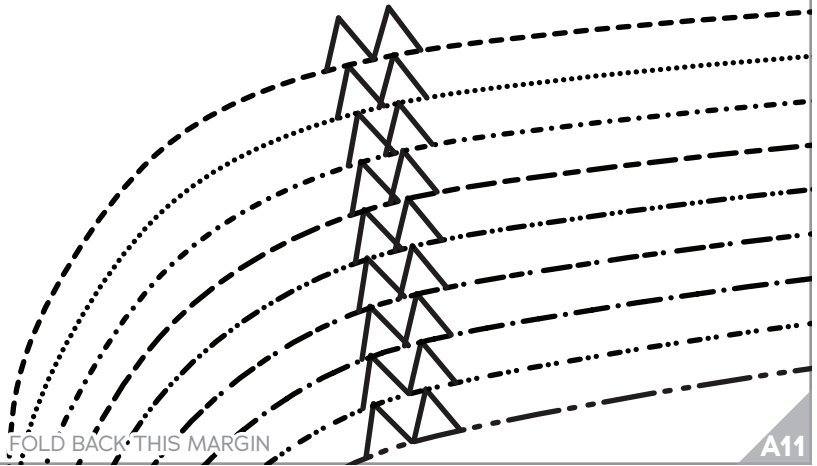

FOLD BACK THIS MARGIN

A10

A11

●
TRIM
ATTACHMENT

PAGE

12

- 18
- 20
- 22
- 24
- 26
- 28
- 30
- 32
- 34

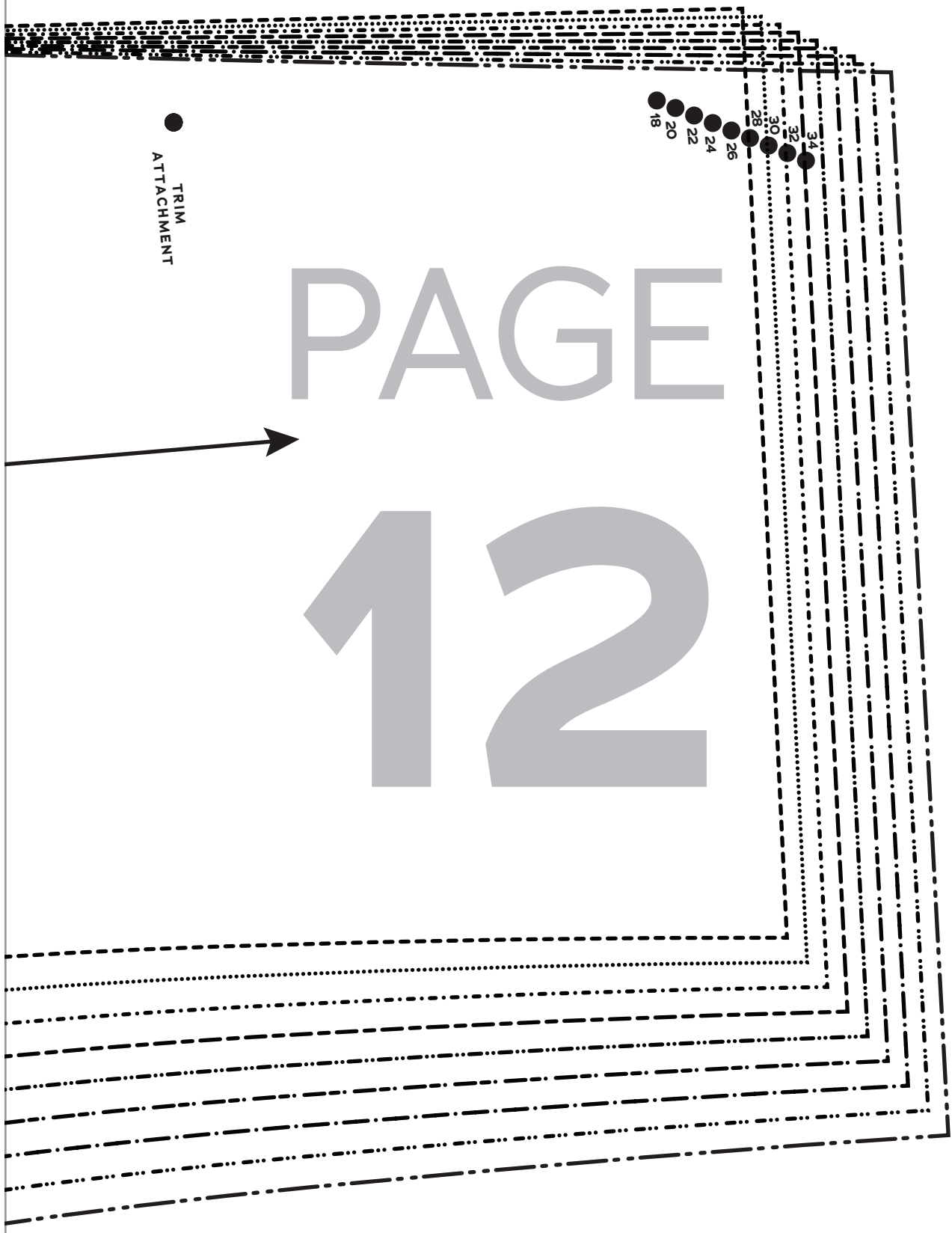

A11

FOLD BACK THIS MARGIN

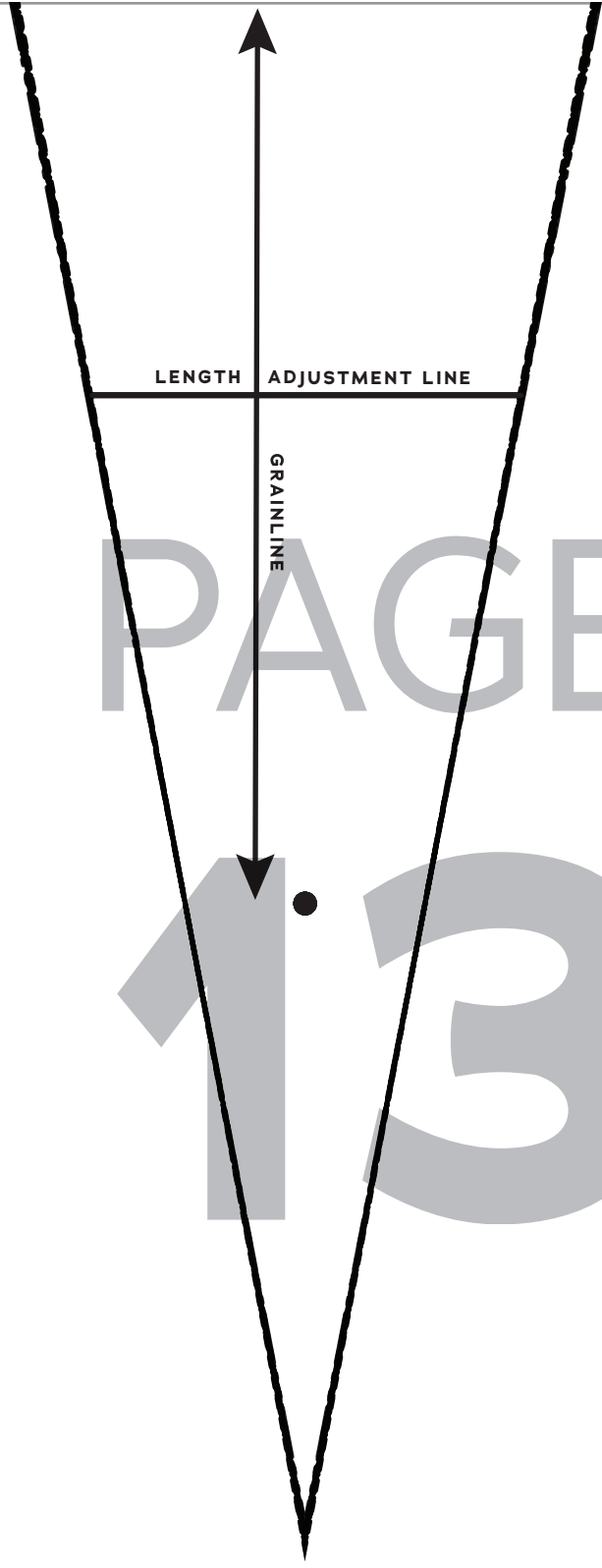

PAGE
13

FOLD BACK THIS MARGIN

FOLD BACK THIS MARGIN

A1

A2

PAGE

14

FOLD BACK THIS MARGIN

B1

FOLD BACK THIS MARGIN

B2

A2

A3

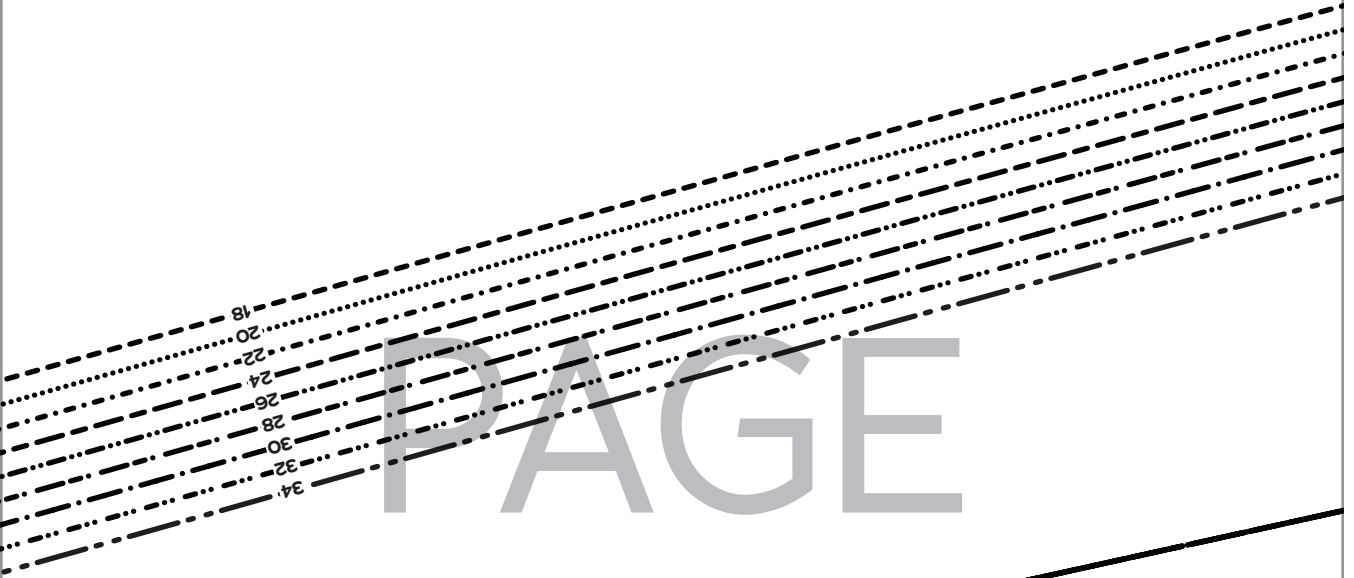

PAGE 15

FOLD BACK THIS MARGIN

B2

FOLD BACK THIS MARGIN

B3

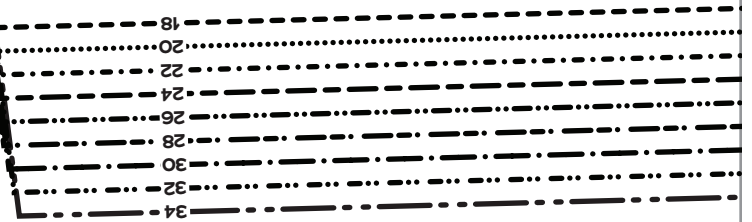

A3

A4

PAGE

16

LENGTH ADJUSTMENT LINE

FOLD BACK THIS MARGIN

B3

FOLD BACK THIS MARGIN

B4

A4

A5

PAGE

Society
 of CHARM
 Starlet
 GOWN
 SIZES 18-34
 4
 Skirt
 Front
 Cut 1 fabric on fold

FOLD BACK THIS MARGIN

B4

FOLD BACK THIS MARGIN

B5

A5

A6

FOLD

PAGE 18

FOLD BACK THIS MARGIN

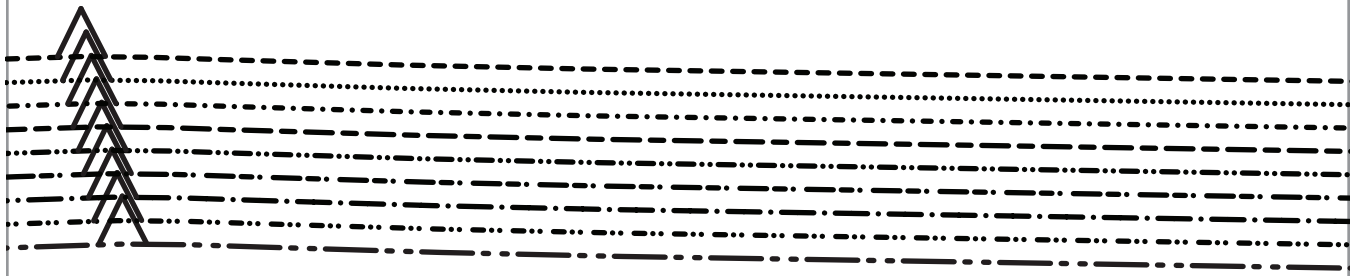

B5

FOLD BACK THIS MARGIN

B6

A6

A7

SHORT SKIRT

PAGE 19

FOLD BACK THIS MARGIN

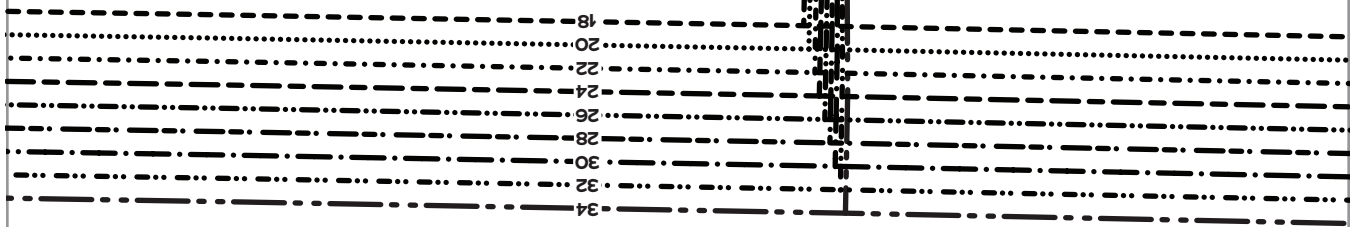

B6

FOLD BACK THIS MARGIN

B7

A7

A8

PAGE

20

FOLD BACK THIS MARGIN

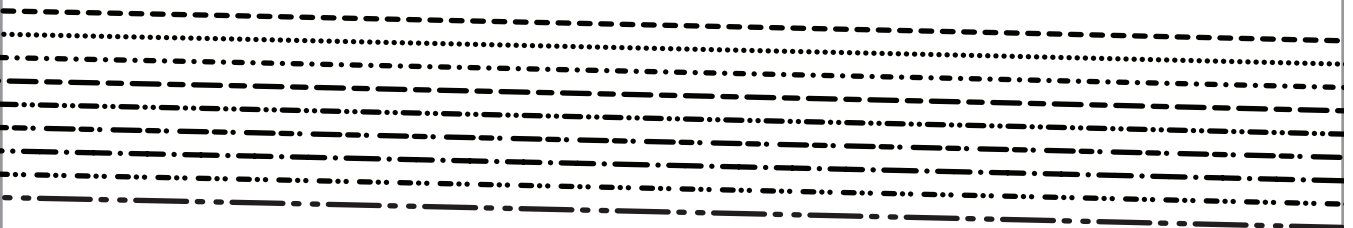

B7

FOLD BACK THIS MARGIN

B8

A8

A9

PAGE 21

FOLD BACK THIS MARGIN

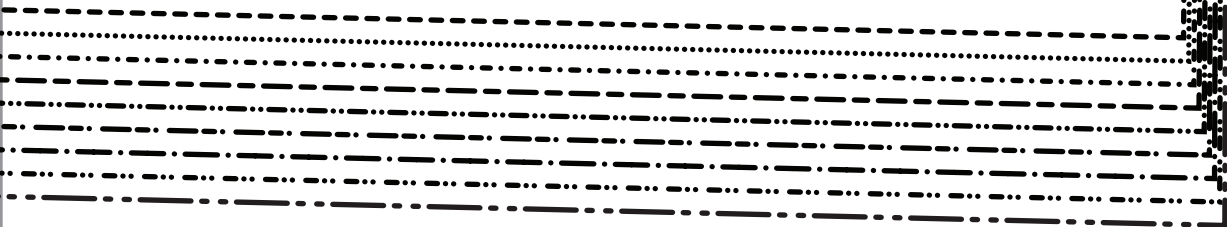

B8

FOLD BACK THIS MARGIN

B9

A9

A10

PAGE
22

18
20
22
24
26
28
30
32
FOLD BACK THIS MARGIN

B9

FOLD BACK THIS MARGIN

B10

A10

A11

PAGE

23

FOLD BACK THIS MARGIN

B10

FOLD BACK THIS MARGIN

B11

PAGE

24

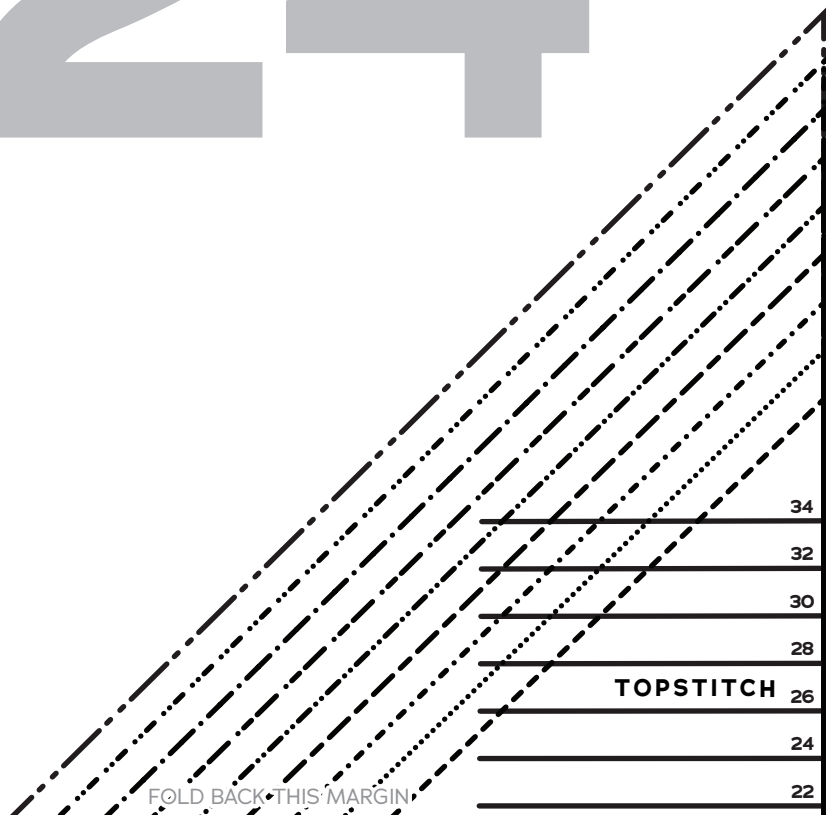

PAGE
25

FOLD BACK THIS MARGIN

34

32

30

28

26

24

22

20

18

FOLD BACK THIS MARGIN

B1

B2

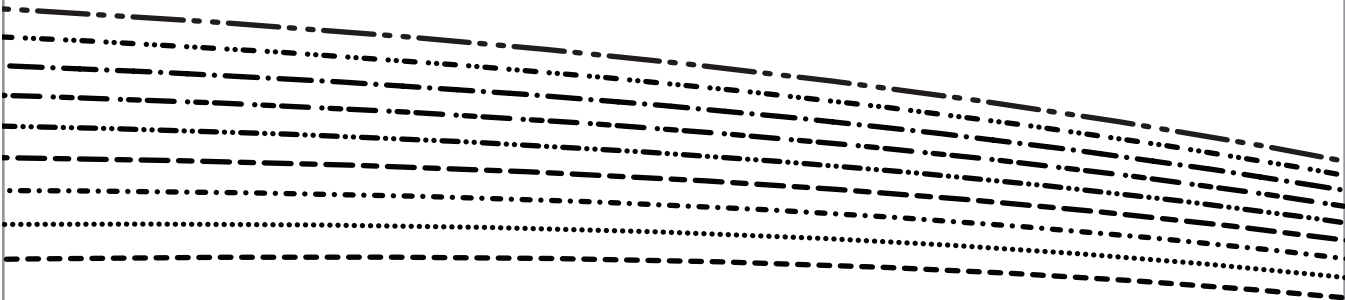

PAGE

26

FOLD BACK THIS MARGIN

C1

FOLD BACK THIS MARGIN

C2

B2

B3

PAGE

27

FOLD BACK THIS MARGIN

C2

FOLD BACK THIS MARGIN

C3

B3

B4

PAGE

28

FOLD BACK THIS MARGIN

FOLD BACK THIS MARGIN

C3

C4

B4

B5

PAGE

29

FOLD BACK THIS MARGIN

34
32
30
28
26
24
22
20
18

C4

FOLD BACK THIS MARGIN

C5

B5

B6

PAGE 30

FOLD BACK THIS MARGIN

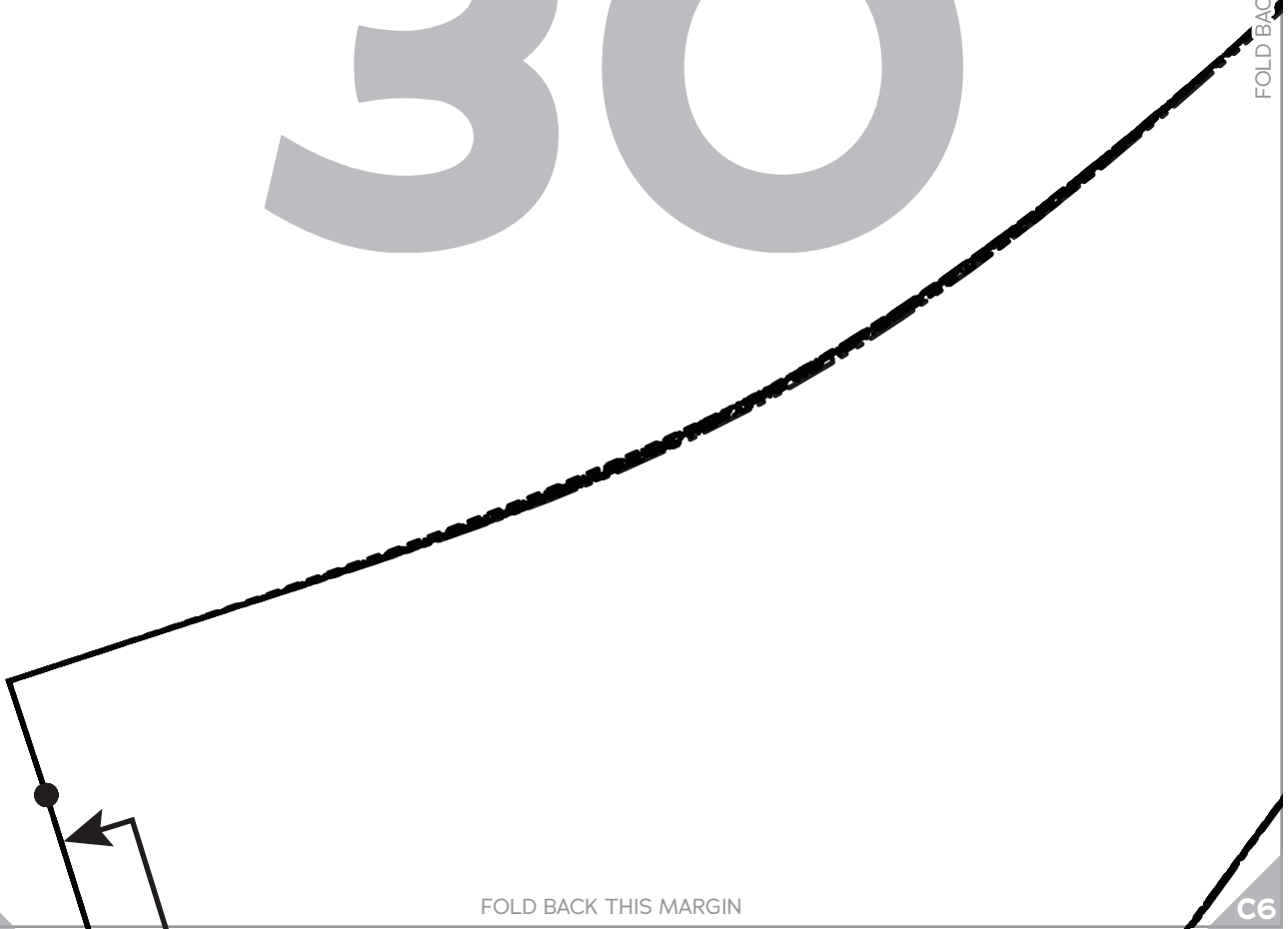

C5

FOLD BACK THIS MARGIN

C6

B6

B7

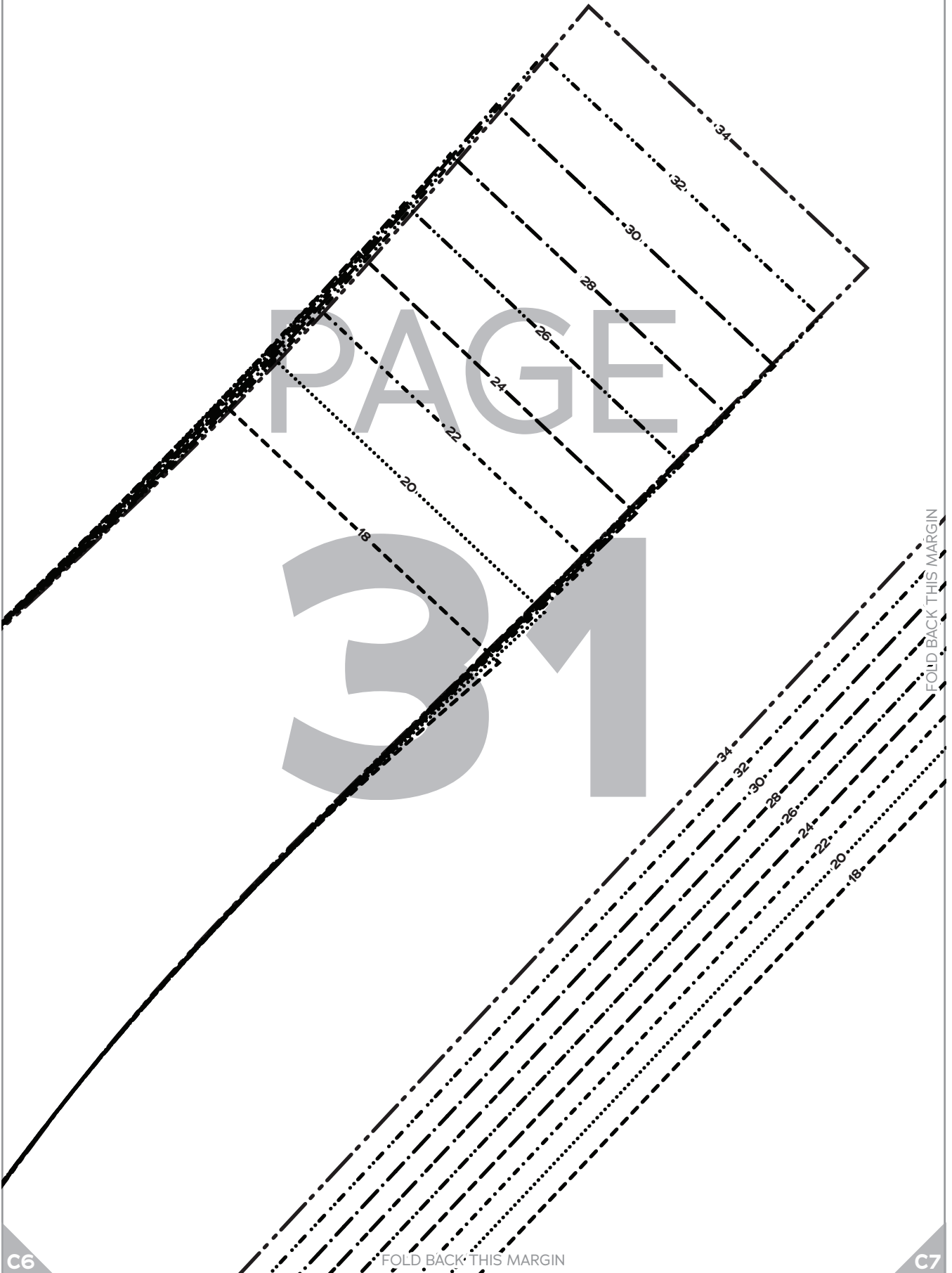

C6

FOLD BACK THIS MARGIN

C7

B7

B8

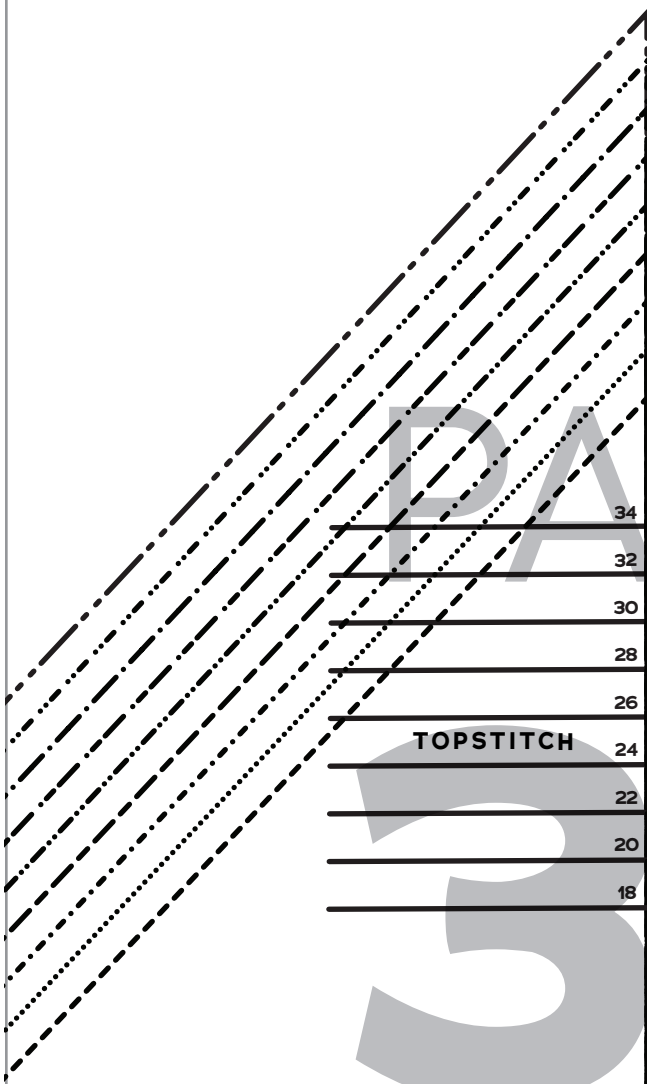

TOPSTITCH

34

32

30

28

26

24

22

20

18



FOLD BACK THIS MARGIN

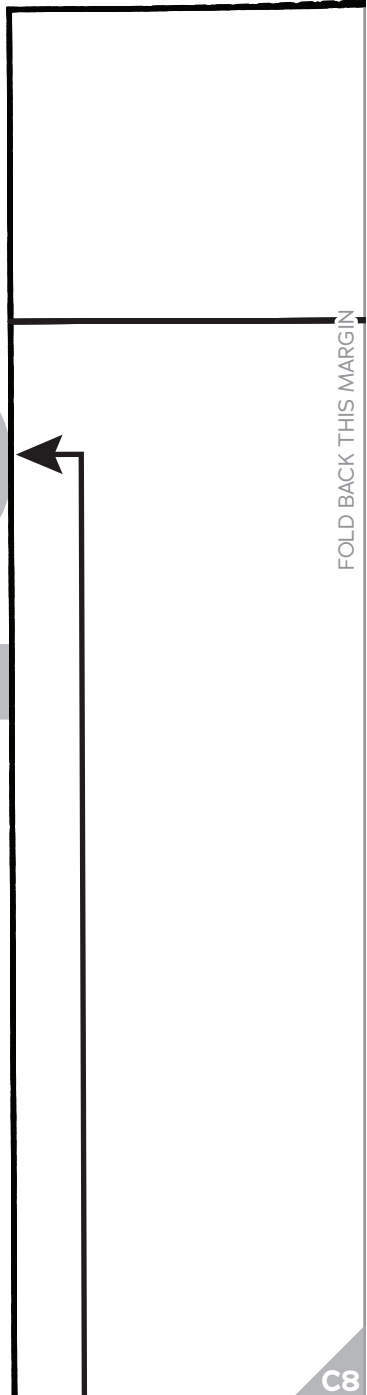

FOLD BACK THIS MARGIN

C7

C8

B8

B9



PAGE

LENGTH ADJUSTMENT LINE

33

FOLD BACK THIS MARGIN

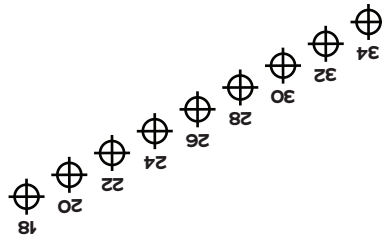

C8

FOLD BACK THIS MARGIN

C9

B9

B10

PAGE

34

FOLD BACK THIS MARGIN

C9

FOLD BACK THIS MARGIN

C10

PAGE

35

FOLD BACK THIS MARGIN

34 32 30 28 26 24 22 20 18

B11

20

18

26
24
22
20
18

PAGE

36



C11

FOLD BACK THIS MARGIN

PAGE

37

FOLD BACK THIS MARGIN

FOLD BACK THIS MARGIN

C1

C2

PAGE

38

FOLD BACK THIS MARGIN

SHORT SKIRT CUTTING LINE

D1

FOLD BACK THIS MARGIN

D2

C2

C3

PAGE

39

FOLD BACK THIS MARGIN

FOLD BACK THIS MARGIN

D3

D2

C3

C4

34

32

30

28

26

24

22

20

18

PAGE

40

FOLD BACK THIS MARGIN

D3

FOLD BACK THIS MARGIN

D4

C4

C5

LENGTH ADJUSTMENT LINE

PAGE

41

*Society
of CHARM*
Starlet
GOWN
SIZES 18-34

5
Skirt Side
Front
Cut 2 fabric

FOLD BACK THIS MARGIN

D4

FOLD BACK THIS MARGIN

D5

C5

C6

Society
of CHARM
Starlet
GOWN
SIZES 18-34

7
Skirt Back
Yoke

Cut 1 fabric on fold

FOLD

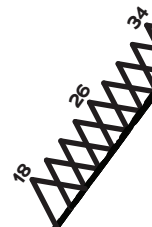

PAGE
42



FOLD BACK THIS MARGIN

D5

FOLD BACK THIS MARGIN

D6

C6

C7



PAGE

24 22 20 18
● ● ● ●

43

*Society
of CHARM*
Starlet
GOWN
SIZES 18-34

FOLD BACK THIS MARGIN

1

Bodice
Front,
H Cup

Cut 1 fabric on fold,
1 lining on fold

D6

FOLD BACK THIS MARGIN

D7

C7

C8

PAGE

44

FOLD

FOLD

FOLD BACK THIS MARGIN

D7

FOLD BACK THIS MARGIN

D8

C8

C9

Cut 1 fabric on fold,
1 lining on fold

Bodice
Front,
A-C Cup

↓
PAGE

SIZES 18-34

GOWN

Starlet
Society
of CHARM

45

FOLD BACK THIS MARGIN

18
20
22

D8

FOLD BACK THIS MARGIN

D9

C9

C10

PAGE

46

FOLD BACK THIS MARGIN

2
24
26
28
30
32
34

D9

FOLD BACK THIS MARGIN

D10

C10

C11

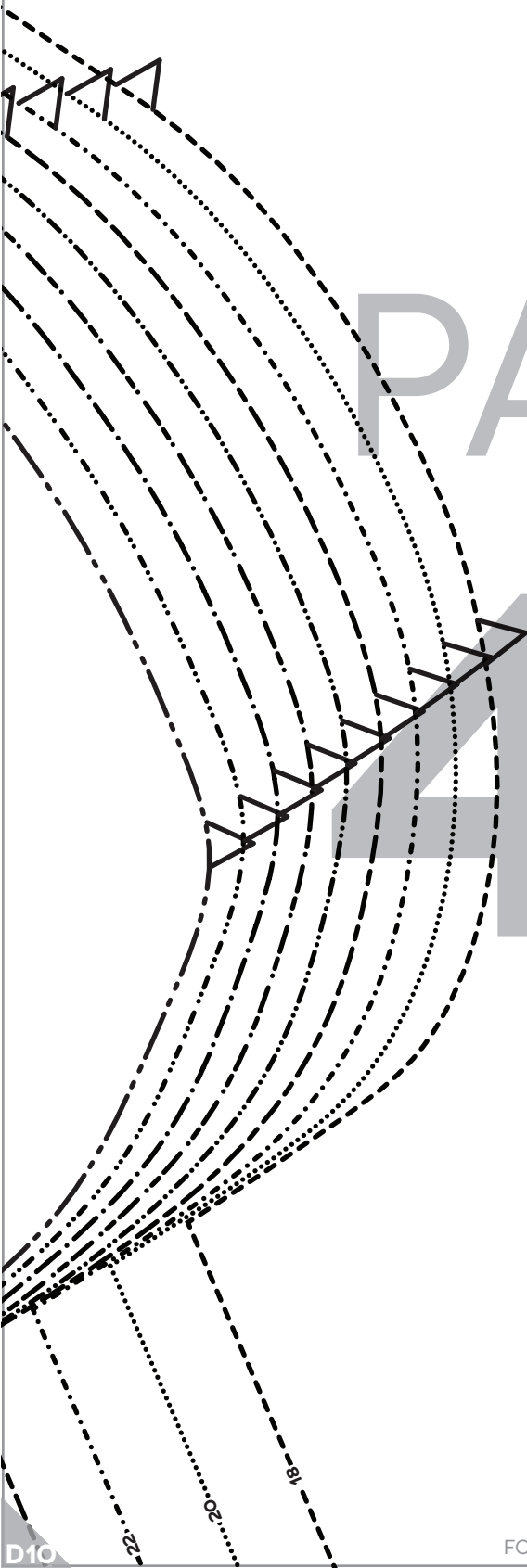

PAGE

47

FOLD BACK THIS MARGIN

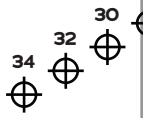

D10

FOLD BACK THIS MARGIN

D11

C11

Society
of CHARM
Starlet

GOWN
SIZES 18-34

1 **PAGE**
Bodice
Front,
D-G Cup

Cut 1 fabric on fold,
1 lining on fold

48

FOLD

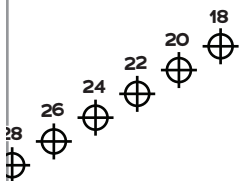

D11

FOLD BACK THIS MARGIN

PAGE

49

FOLD BACK THIS MARGIN

FOLD BACK THIS MARGIN

D1

D2

GRAINLINE

PAGE

50

FOLD BACK THIS MARGIN

Cut 2 fabric

Skirt Side
Back

8

SIZES 18-34

GOWN

Starlet
Society
of CHARM

E1

FOLD BACK THIS MARGIN

E2

D2

D3

PAGE
51

FOLD BACK THIS MARGIN

E2

FOLD BACK THIS MARGIN

E3

D3

D4

E3

E4

PAGE

52

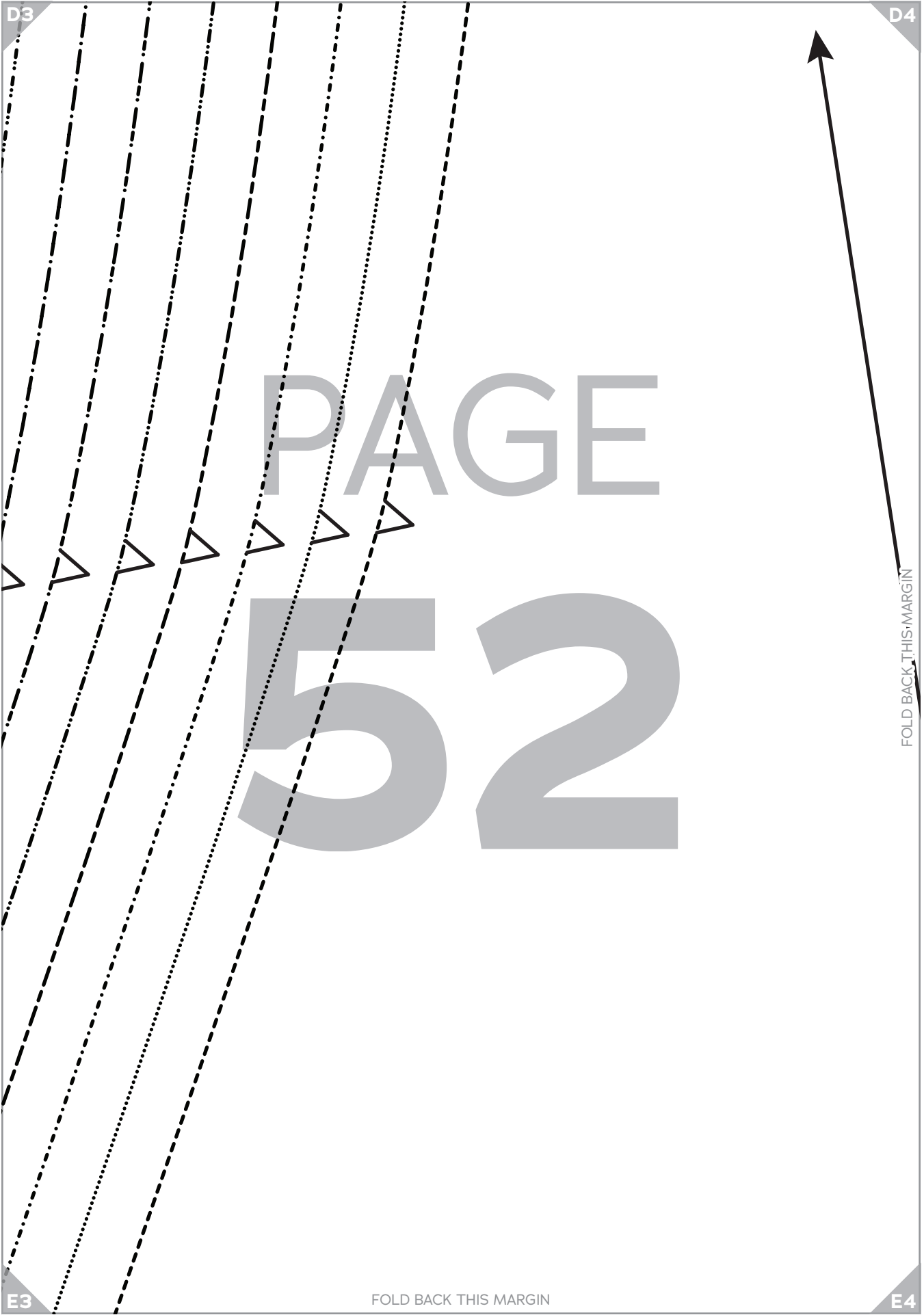

D4

D5

PAGE 53



GRAINLINE

FOLD BACK THIS MARGIN

E4

FOLD BACK THIS MARGIN

E5

D5

D6

PAGE

54

FOLD BACK THIS MARGIN

E5

FOLD BACK THIS MARGIN

E6

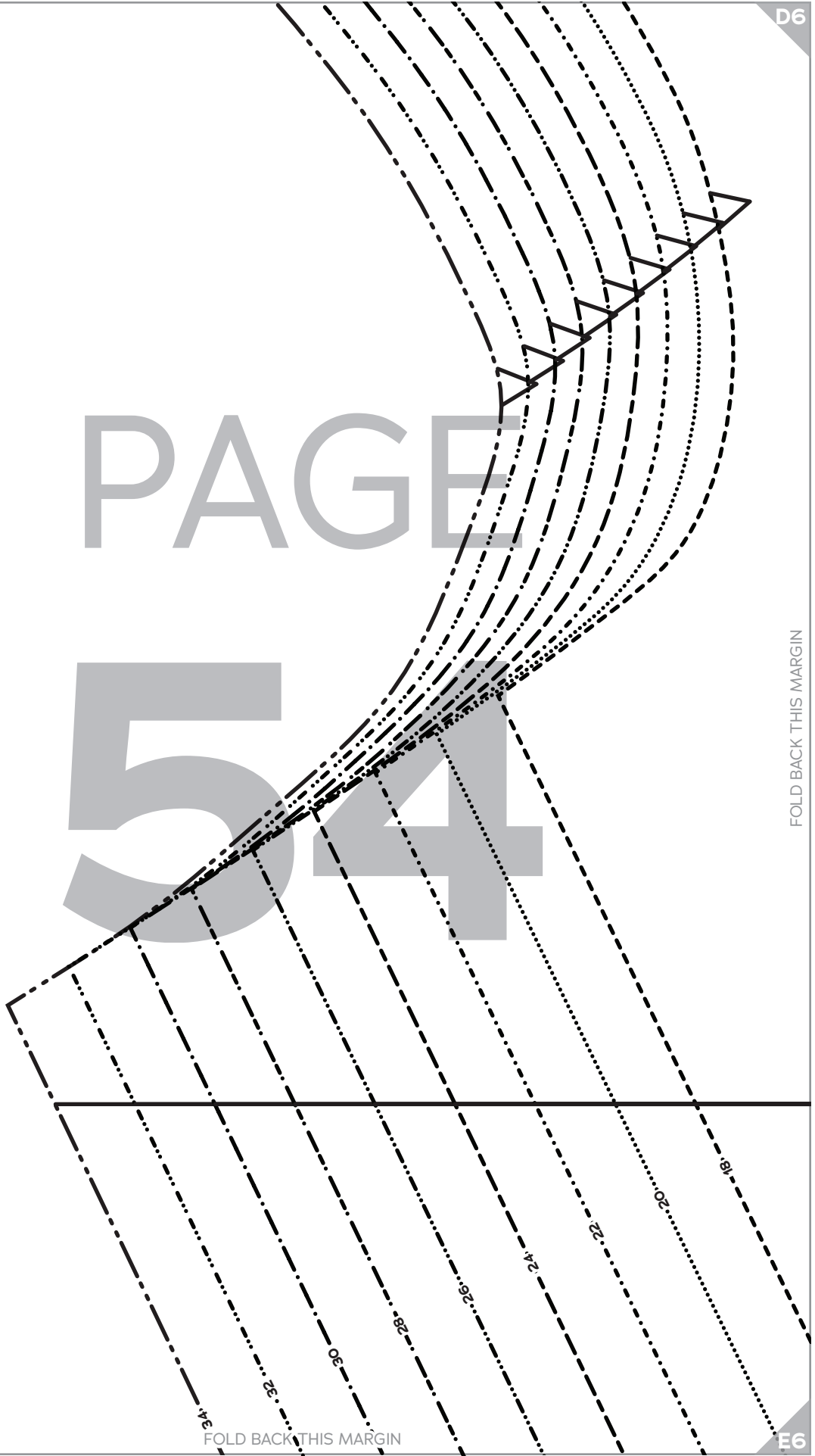

PAGE

55

FOLD BACK THIS MARGIN

LENGTH ADJUSTMENT LINE



FOLD BACK THIS MARGIN

D7

D8

PAGE
56

FOLD BACK THIS MARGIN

18
20
22
24
26
28
30
32
34

TOPSTITCH



D8

D9

PAGE

57

FOLD BACK THIS MARGIN

D9

D10

PAGE 58

FOLD BACK THIS MARGIN

D10

D11

PAGE

59

FOLD BACK THIS MARGIN

LENGTH ADJUSTMENT LINE

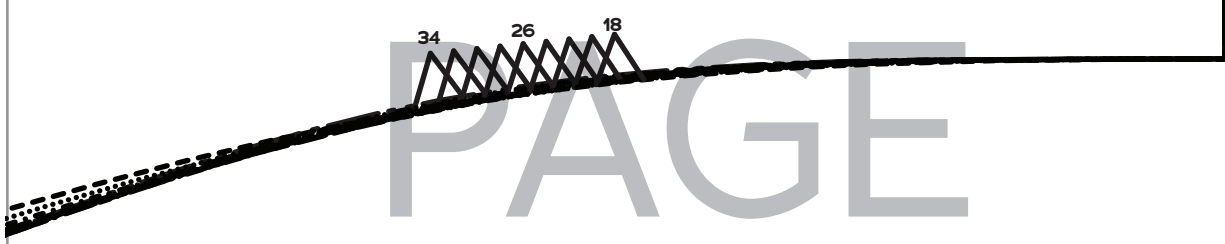

PAGE

60

PAGE

61

FOLD BACK THIS MARGIN

34"

32"

30"

28"

26"

24"

22"

20"

18"

FOLD BACK THIS MARGIN

E1

E2

PAGE 62

FOLD BACK THIS MARGIN

LENGTH ADJUSTMENT LINE

F1

FOLD BACK THIS MARGIN

F2

E2

E3

PAGE

63

FOLD BACK THIS MARGIN

F2

FOLD BACK THIS MARGIN

F3

E3

E4

SHORT SKIRT CUTTING LINE

18

20

22

24

26

28

30

32

34

PAGE

64

FOLD BACK THIS MARGIN

F3

FOLD BACK THIS MARGIN

F4

E4

E5

PAGE

65

FOLD BACK THIS MARGIN

34
32
30
28
26
24
22
20
18

F4

FOLD BACK THIS MARGIN

PAGE

66

FOLD BACK THIS MARGIN

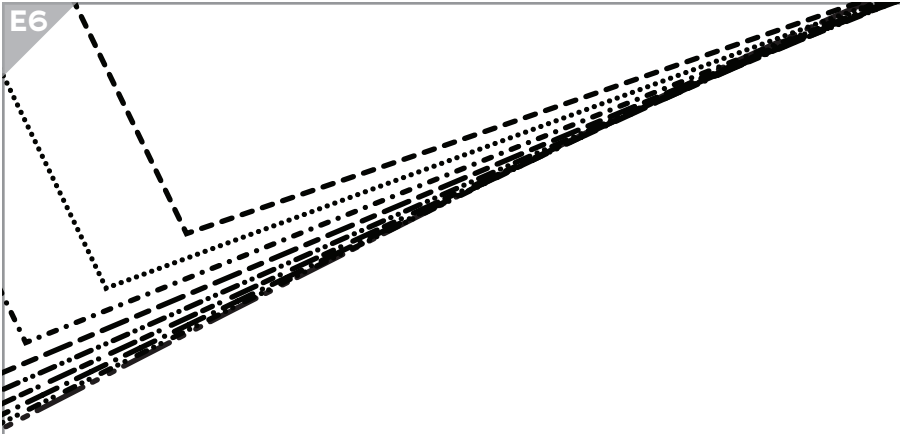

PAGE

67

PAGE

68

FOLD BACK THIS MARGIN

F1

F2

PAGE

69

34
32
30
28
26
24
22
20
18

FOLD BACK THIS MARGIN

F2

F3

34

32

30

28

26

24

22

20

18

PAGE
70

FOLD BACK THIS MARGIN

F3

F4

PAGE

71

FOLD BACK THIS MARGIN

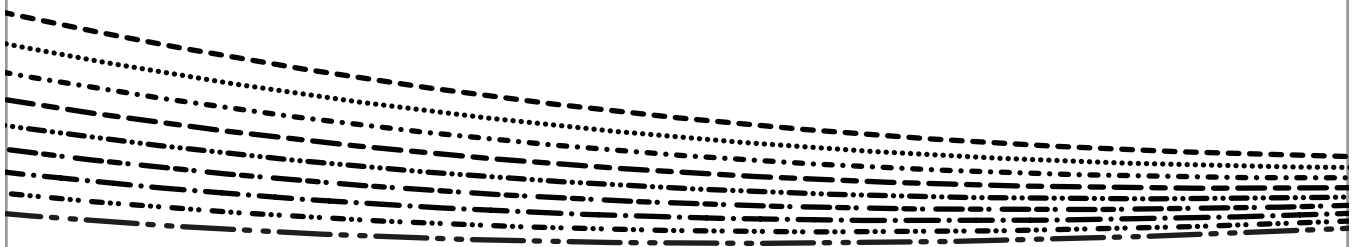

PAGE 72

